

TL-2020 PE

JUKI

Special Limited Collector's Edition



Semi-Professional Sewing Machine

TL-2020 PE
PLATINUM EDITION **2020**

JUKI celebrates 80+ years with the Collector's Special Platinum Edition TL-2020 PE.

From its Platinum exterior and high-quality features, the TL-2020 PE is designed and crafted to the highest JUKI standard. Only 2,000 sets produced for the United States.



TL-2020 PE PLATINUM EDITION

[Specifications]

Sewing Speed : Min. 55 - Max. 1,500SPM
 Lift of the Presser Foot : By lever 7mm, by knee lifter 12mm
 Dimensions : 452(W) x 350(H) x 219(D)mm
 Auxiliary table (dimensions) : 590(W) x 335(D)mm
 Hook : Horizontal-axis full-rotary hook

Stitch Length : Max. 6mm
 Needle : HA x 1 (130/705H) / HL x 5 #9-#18
 Weight (machine only) : 11.9Kg / 26.2Lb
 Light : LED
 Rated voltage/power consumption : 120V/1.1A

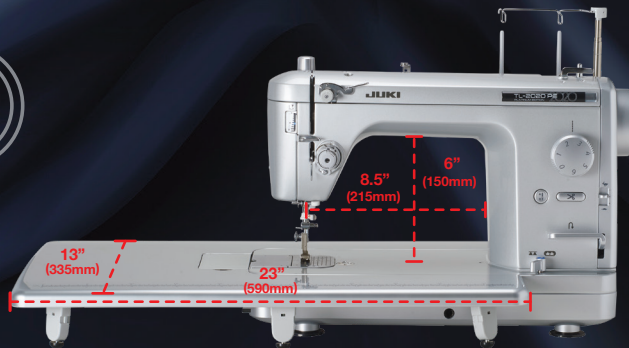

Sub Tension Unit

No matter the thread type, sub-tension ensures stitches are sewn with a balanced thread tension. Achieve perfectly balanced threads with every stitch.

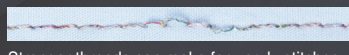

Stronger threads can make for unruly stitches.

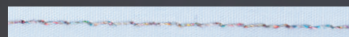

Sub-tension creates steady stitches by putting an end to stitches that come up.



Foot Controller with Thread Trimming Function

Automatically trim thread by pressing the controller with your heel. *Automatic thread trimming can be turned off by attaching a foot switch stopper.



Maximum Sewing Speed Control

The sewing speed can be set between 200 and 1,500 stitches per minute when using the foot controller.



Automatic Thread Trimmer

Industrial sewing machine technology provides exceptional durability, noise control and cutting.



Automatic Needle Threader

The automatic needle threader quickly and easily threads the needle without eyestrain.



Needle Up/Down Control

Change the needle position to up or down as desired by simply pressing the button. When the button is pressed continuously, the machine will sew stitch by stitch.



Knee Lifter Lever

The knee lifter lever allows you to lift/low the presser foot without using your hands. The presser foot can be raised as high as 12mm.



Thread Tension Scale

The thread tension scale allows you to adjust the tension according to the thread and material to be used.



Presser Foot Pressure Adjustment

Turn the regulator on top of the machine to adjust the presser foot pressure according to the thickness of the fabric.

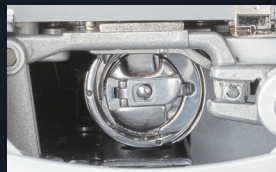

Horizontal-axis Full-rotary Hook

Create perfectly balanced stitches for beautiful seams. Bobbin thread tension is also adjustable.

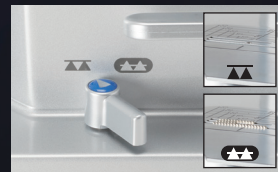

Drop Feed

The feed dog may be raised or lowered by simply adjusting the switch. Lowering the feed dog allows you to free motion quilt in any direction with precision and ease.



Attachment Mounting Plate

A separate attachment mounting plate for installing fabric guides and other attachments.

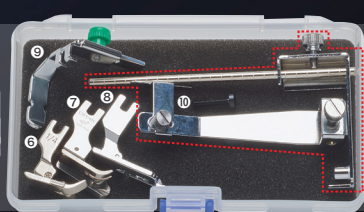
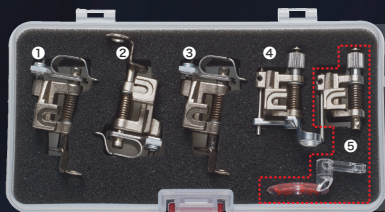

TL-2020 PE ACCESSORY BOX

- 1 1/5" Quilting Foot
- 2 1/4" Quilting Foot
- 3 Quilting Foot Front Open Toe
- 4 1/4" Quilting Foot (for Ruler)
- 5 Echo Quilting Foot
- 6 1/4" Presser Foot
- 7 Compensating Foot (Right 1/4")
- 8 Hemming Foot
- 9 Zipper Attaching Foot
- 10 Quilt Guide for Even Feed Foot



Even Feed Foot (Accessory bag)

JUKI
 JUKI CORPORATION

2-11-1, TSURUMAKI, TAMA-SHI, TOKYO
 206-8551, JAPAN
<https://www.juki.co.jp>

JUKI AMERICA INC.

8500 N.W 17th STREET SUITE 100
 MIAMI, FL 33126-1008, U.S.A.
 TEL: 1-305-594-0059 FAX: 1-305-594-0720
<http://www.juki.com>

JUKI ECO PRODUCTS

This is an eco-friendly product which complies JUKI ECO PRODUCTS standards for protecting the environment.



The sewing machine complies with the "JUKI Group Green Procurement Guidelines" on the use of hazardous substances, which is stricter than other restrictions, such as those of the RoHS Directive.

For details of JUKI PRODUCTS, refer to:
https://www.juki.co.jp/eco_e/index.html

*The RoHS Directive is an EU Directive limiting the use of 6 hazardous substances (lead, hexavalent chromium, mercury, cadmium, PBB and PBDE) in electrical and electronic equipment. The JUKI Green Procurement Guideline is the voluntarily established criteria to eliminate not only the aforementioned six substances, but also other ones which also adversely affect the environment.