

## Creating a Border using Skew 2

- Press **Design**.
- Press **File**.
- Press **Open**.
- Press **Designs**.
- Press **HQ Designs**.
- Press **Continuous Line**.
- Press **Dump Truck**.

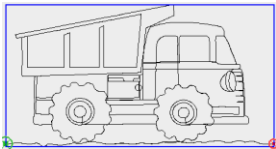

- Press **Open**.
- Press **Area**.
- Create an **Area** similar to the one below using **Multi-Point**.

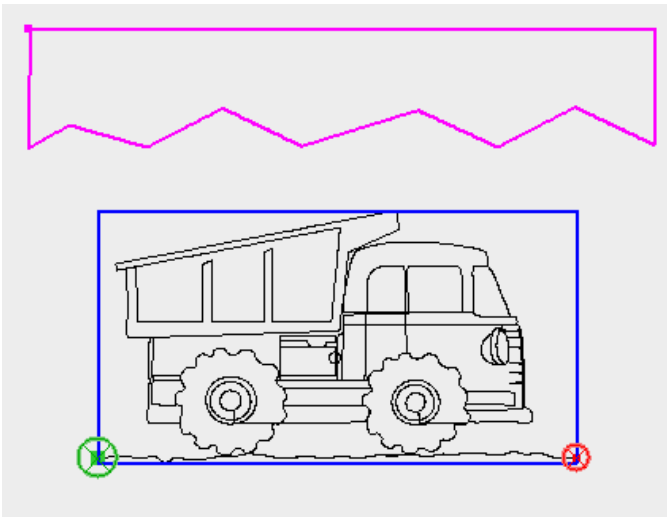

- Notice the Dump Truck is quite a bit larger than the area in height and at this point only one would fit the width.
- The area that was created is approximately 3" x 16".
- The Dump truck is 12.25" x 6.45".

- Press **Skew/Align**.

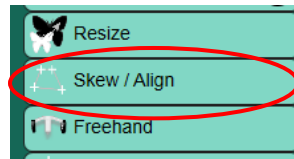

- Press **Skew 2**.

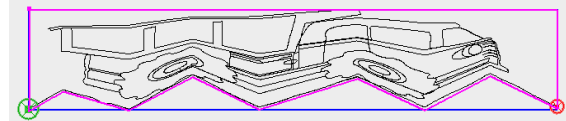

- Press **Repeat**.
- Press the **"Plus"** button and add repeats to create the Dump Truck running up and down the hills. Add as many repeats as desired.

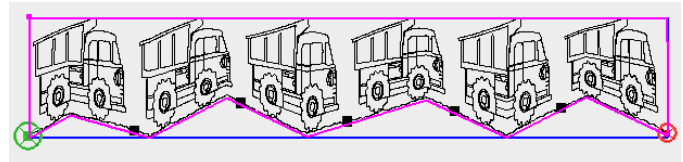
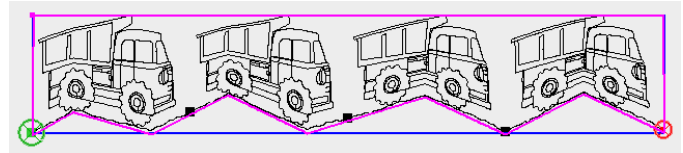

- Try some other designs to see how they skew. Adding or subtracting repeats may help the design look better.

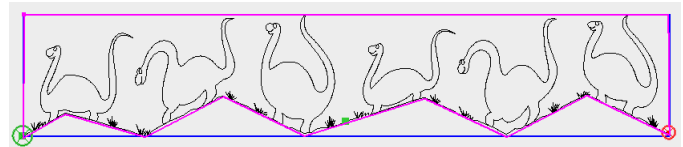
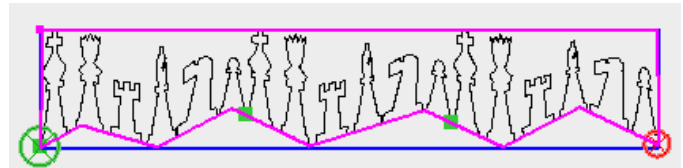

- Create an area like this. This will require many **Multi-Points** to create the uneven lines.

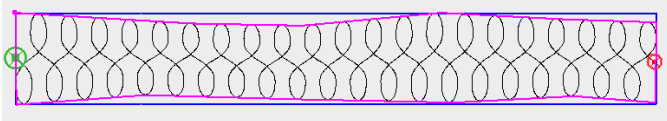
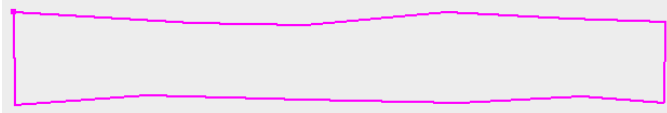

- The designs follows the border even if it is uneven.

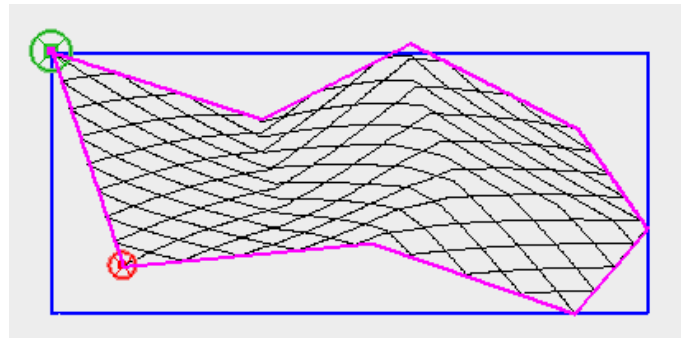
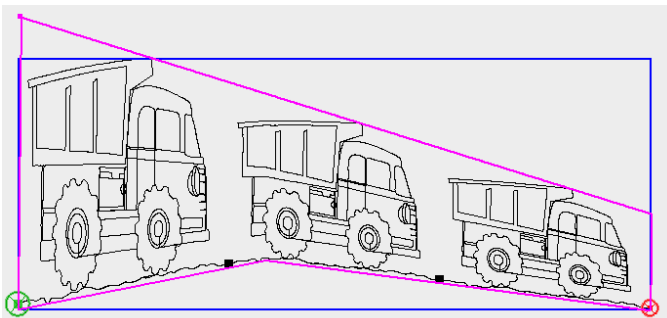
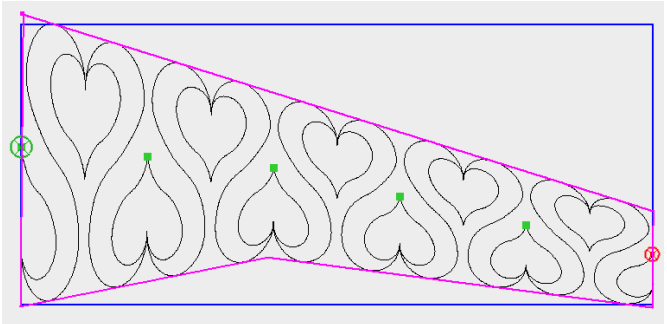
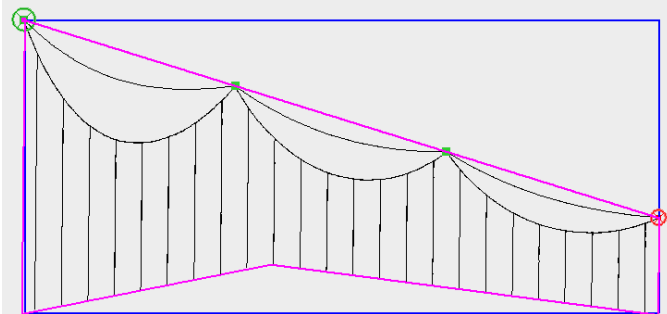
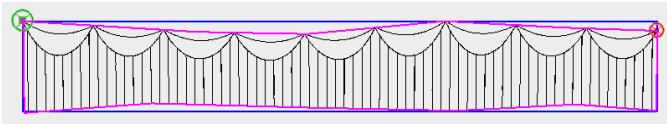
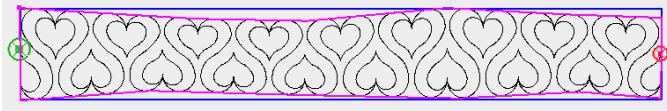

Use the **Crosshatch Design** repeated across the area of the border.

