

SINGER®

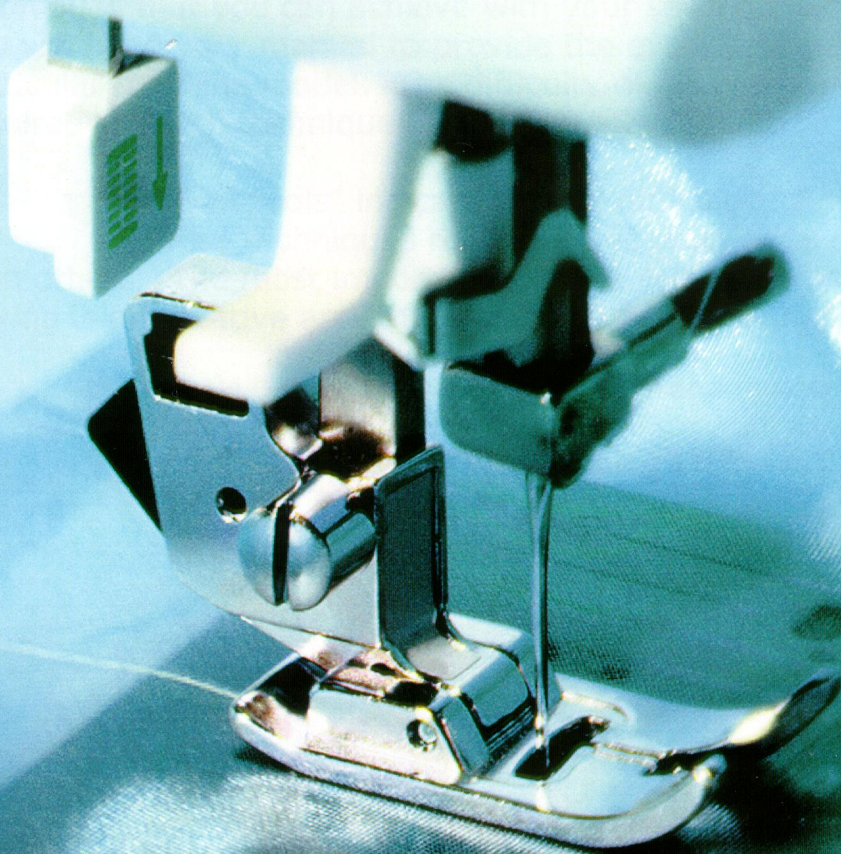



Workbook
Scholastic & Scholastic Plus

Welcome to

SINGER®



This workbook is designed to teach basic and advanced sewing techniques that you can achieve with your sewing machine. You will need your manual to provide the exact settings for your particular machine model. The difficulty or skill level required for each technique is rated by this symbol: 

 "Two spools" indicate a more difficult technique. These techniques require more practice to master than others. The most important thing to remember is that sewing is an creative art—there are very few absolutes.

So have fun as you learn these exciting techniques! 



Table of Contents

Straight Stitching	1
Straight Stitch for Topstitching	2
Create Quilted Fabric	3
Speed Basting	4
Making Piping	5
Attaching Purchased Piping	6
Centered Zippers	7
Satin Stitch Applique	9
Lace Insertion	11
Couching a Strand of Pearls	13
Button Sewing	14
Four-Step Buttonholes	16
One-Step Buttonholes	18
Four-Step Corded Buttonholes	20
One-Step Corded Buttonholes	22
Free-Motion Monogramming	24
Free-Motion Embroidery	26
Blind Hem	28
Attaching Beaded Trims	30
Mending with Multi-Stitch Zigzag	31
Crazy Quilting	32
Scallop Edging	33
Straight Stretch Stitch for Woven Fabrics	34
Straight Stretch Stitch for Stretch Fabrics	35
Ribbing Application	36
Overedge Stitching	37
Open Seams with Overedge Stitching	38
Attaching Elastic	39
Sewing with a Wing Needle	40
Twin Needle Sewing	41

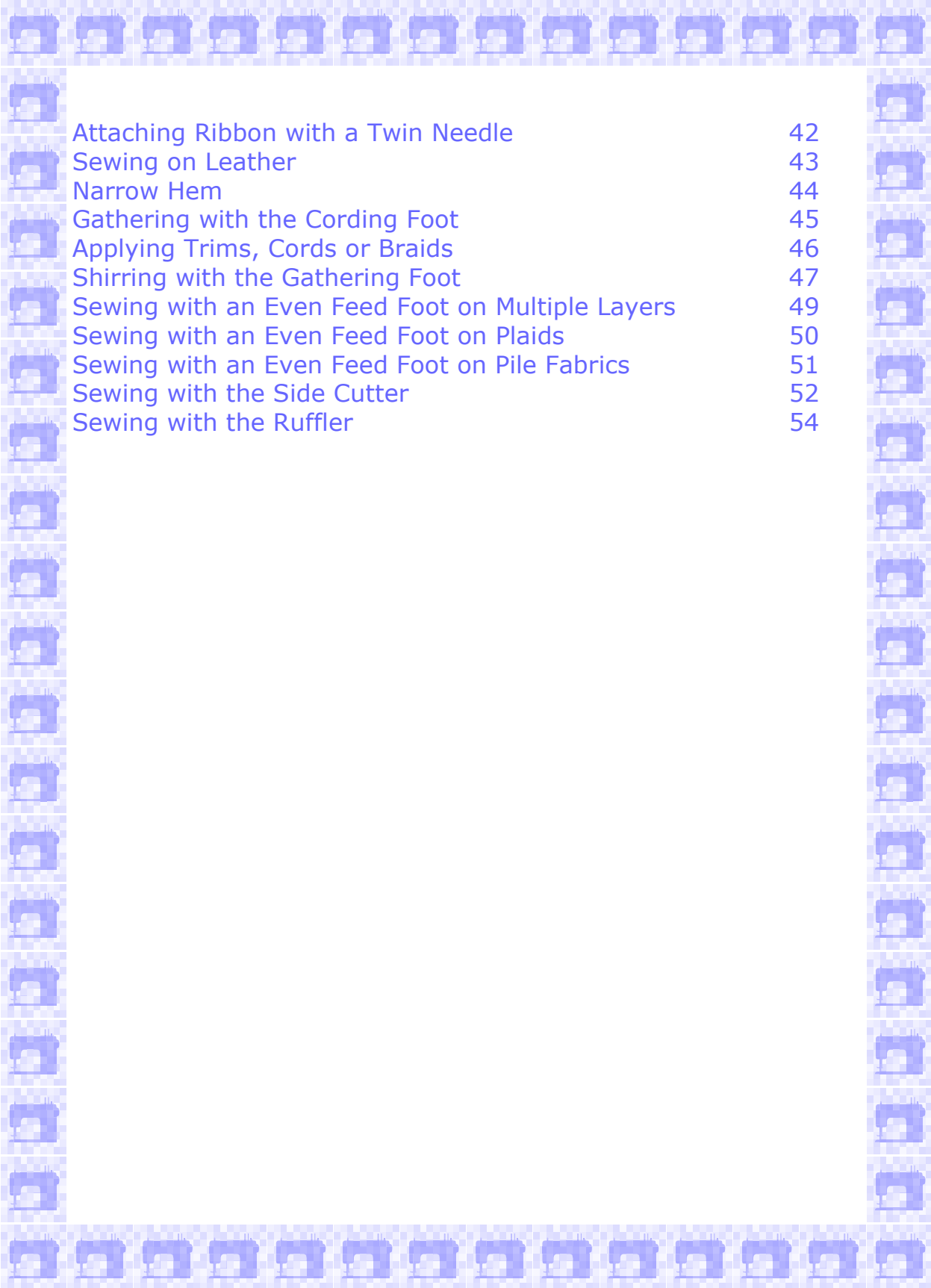

Attaching Ribbon with a Twin Needle	42
Sewing on Leather	43
Narrow Hem	44
Gathering with the Cording Foot	45
Applying Trims, Cords or Braids	46
Shirring with the Gathering Foot	47
Sewing with an Even Feed Foot on Multiple Layers	49
Sewing with an Even Feed Foot on Plaids	50
Sewing with an Even Feed Foot on Pile Fabrics	51
Sewing with the Side Cutter	52
Sewing with the Ruffler	54

Straight Stitching



The Straight Stitch is generally used to join seams or do topstitching. It is the most basic of the stitches and is the most commonly used. For a longer stitch or for thicker fabrics, lengthen the stitch using the Stitch Length Dial.

Machine Set-Up:

Stitch:	Straight Stitch
Stitch Width:	0, no width
Stitch Length:	3-4
Presser Foot:	Standard Foot



Materials:

(2) 4" x 4" pieces of cotton, right sides together

Procedure:

- ◆ Place fabrics under the foot, matching the raw edges with the 5/8" seam guide.
- ◆ Sew the length of the fabric.
- ◆ Use the Reverse Lever to reinforce the seam.

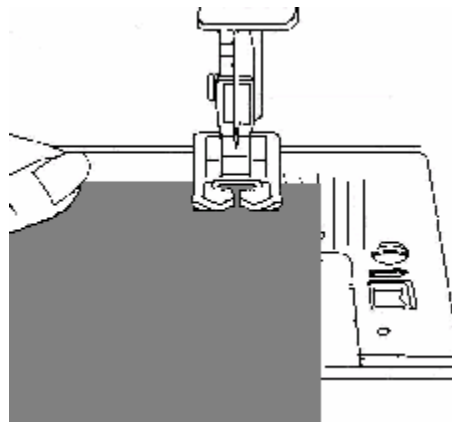
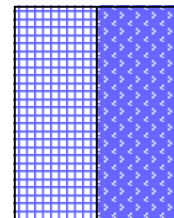

Straight Stitch for Topstitching



The Straight Stitch can be sewn “on top” of the fabric so that the stitches are visible. This is different from using the straight stitch to join a seam hidden inside the project. A topstitch provides a decorative touch while holding the seam allowances flat. It is also sturdy and durable.

Machine Set-Up:

Stitch:	Straight Stitch
Stitch Width:	0, no width
Stitch Length:	3-4
Presser Foot:	Standard Foot



Materials:

(2) 5” x 5” pieces of cotton with batting between the two pieces, creating a quilt-type sample

Procedure:

- ◆ Sew diagonally from the top left corner to the bottom right corner.
- ◆ Use the Reverse Lever to reinforce the seam.

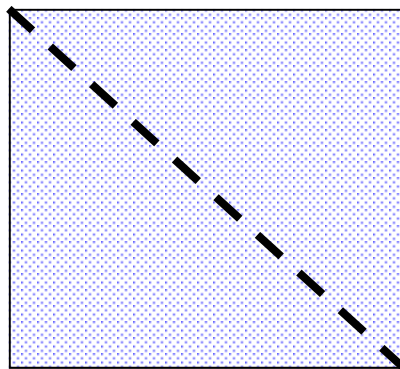

Create Quilted Fabric



Create your own quilted fabric with the Straight Stitch and the Seam/Quilt Guide. This attachment is great when sewing large projects that cover the machine's seam guides.

Machine Set-Up:

Stitch: Straight Stitch
Stitch Width: 0, no width
Stitch Length: 3-4
Presser Foot: Standard Foot

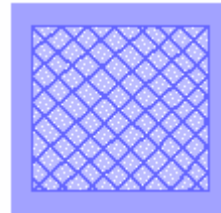

Materials:

Quilt-type sample that was previously used on the "Straight Stitch for Topstitching" page

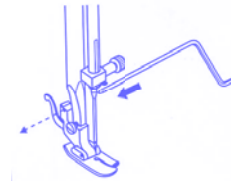

Procedure:

- ◆ Attach the Seam/Quilt Guide.*
- ◆ Use the guide to ensure even spacing and straight lines when large projects cover the machine's seam guides.
- ◆ Position fabric approximately 1-2 inches to the right of the previously sewn straight stitch.
- ◆ Position the guide so that it rides on the previous row of stitching.
- ◆ Sew successive rows using the guide.
- ◆ Change the direction and sew diagonally from the top right corner to the bottom left corner.

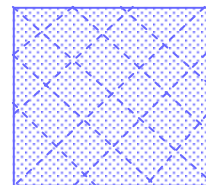
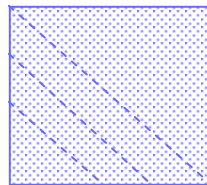
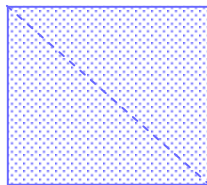

- ◆ Sew 3 or more rows, using the guide.

*Depending on model, the Seam/Quilt Guide might be optional. Check the instruction manual.

Speed Basting



Basting is used to temporarily hold fabrics together. The stitch length and tension are adjusted to create a looser stitch. This stitch can easily be removed with a seam ripper or simply pulled out.

Machine Set-Up:

Stitch:	Straight Stitch
Stitch Width:	0, no width
Stitch Length:	3-4
Presser Foot:	Standard Foot
Tension:	Adjust the tension by setting to a smaller number



Materials:

(2) 4" x 4" pieces of cotton, right sides together

Procedure:

- ◆ Place under the foot, matching the raw edges with the 5/8" seam guide.
- ◆ Sew the length of the fabric.
- ◆ Use the seam ripper to remove a portion of the basting, or simply pull the bobbin thread to completely remove basting.

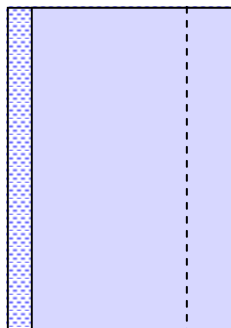

Making Piping



Piping adds a beautiful finish to projects such as pillows, sleeve edges, collars and more. The design of the Zipper Foot allows for the needle to stitch very closely to the edge of the foot. This is important when inserting zippers, applying piping or when topstitching close to the fabric's edge. Only the Straight Stitch can be used when sewing with the Zipper Foot.

Machine Set-Up:

Stitch:	Straight Stitch
Stitch Width:	0, no width
Stitch Length:	3-4
Presser Foot:	Zipper Foot

Materials:

5" x 6" home décor fabric
7" piping cord

Procedure:

- ◆ Fold fabric wrong sides together.
- ◆ Place piping inside of the fold.
- ◆ On the right side of the fabric, sew a straight stitch close to the piping.

Note: The Zipper Foot can be attached right or left, allowing for the piping to be inserted from either side.

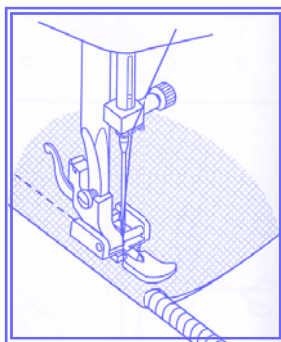

Attaching Purchased Piping



Attach pre-packaged piping to add a bold finish to home decorating projects, crafts or clothing.

Machine Set-up:

Stitch: Straight Stitch
Stitch Width: 0, no width
Stitch Length: 3-4
Presser Foot: Zipper Foot



Materials:

(2) 3" x 6" pieces of home décor fabric
7" pre-packaged piping

Procedure:

- ◆ Place fabric right sides together.
- ◆ Place piping between the fabrics, matching the piping's raw edge with the fabric's raw edges.

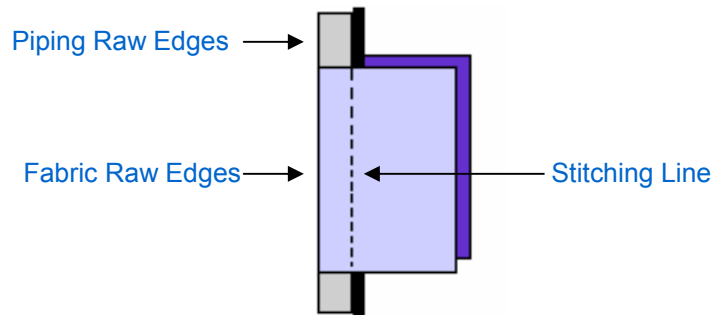

- ◆ On the wrong side of the fabric, sew a straight stitch close to the piping.

Note: The Zipper Foot can be attached right or left, allowing for the piping to be inserted from either side.

Centered Zippers



There are several ways of inserting zippers. The pattern envelope of the project or garment will designate the best type of zipper application, as well as the length and type of zipper to use. Most applications require a zipper foot.

Machine Set-Up:

Stitch: Straight Stitch
Stitch Width: 0, no width
Stitch Length: For basting: longest stitch
For stitching: 3-4
Presser Foot: Zipper Foot
Tension: For basting: loosen the tension
For stitching: Auto

Materials:

- (1) 7" zipper
- (2) 8" x 4" piece of medium weight fabric
- Transparent tape
- Fabric glue stick

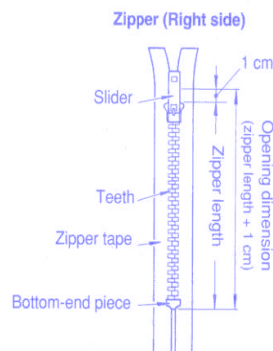

Procedure:

- ◆ Place fabric under the foot, matching the raw edges with the 5/8" seam guide.
- ◆ Starting at the top of the fabric, baste 7". Then, change the stitch length to 3 and finish seaming the remaining length of the fabric.

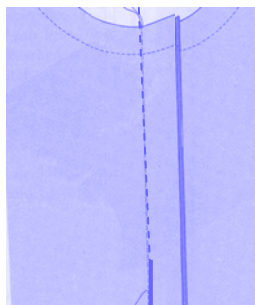

- ◆ Press the seam open. Finish raw edges if necessary.
- ◆ Apply glue stick lightly on the right side of the zipper.
- ◆ Place the zipper face down, so that the zipper's coils or teeth are directly over the machine-basted seam. Pin in place, if necessary.

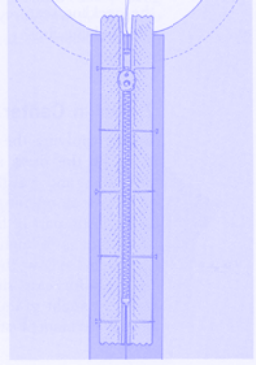

- ◆ Spread fabric flat, right side up and place 1/2" wide transparent or perforated marking tape on top of the centered seam line. The tape should be the length of the zipper (7" long for this exercise).
- ◆ Replace the Standard Presser Foot with the Zipper Foot. Adjust the foot to the left of the needle.
- ◆ On the right side of the fabric, stitch around the zipper. Pivot the fabric on the needle at the corners, using the edge of the tape as a guide.

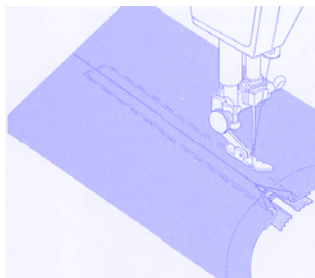

- ◆ Turn fabric to right side and remove the tape and the basting. Press.

Satin Stitch Appliqué



A close Zigzag Stitch is called a Satin Stitch. Satin Stitching is a great way to finish an appliqué on children's garments and home decorating projects. Try a rayon thread for a smoother looking finish.

Machine Set-Up:

Stitch:	Zigzag Stitch
Stitch Width:	2-3
Stitch Length:	1-2
Presser Foot:	Satin Foot * or Standard Foot

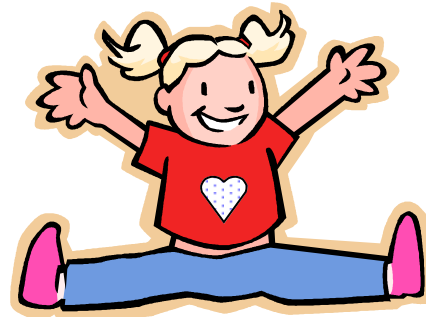

Materials:

- 2" x 3" cotton fabric for simple-shaped applique
- 2" x 3" fusible stabilizer
- 6" x 6" cotton foundation fabric
- 6" x 6" tear-away stabilizer

Procedure:

- ◆ Press the fusible stabilizer onto the simple-shaped applique.
- ◆ Fuse the simple-shaped appliqué onto the cotton foundation fabric. (Fusing the appliqué into place will keep the appliqué from shifting while stitching.)
- ◆ Place a tear-away stabilizer underneath the fabric. (This is used to ensure quality stitching when using dense stitches.)
- ◆ Place the applique under the foot, so that half of the stitch will form on the applique and half on the base fabric.
- ◆ Sew around the applique.
- ◆ Widen the stitch width to 4 and change the stitch length to below 1.

*Depending on model, the Satin Foot might be optional. Check the instruction manual.

- ◆ Sew around the applique again, covering the previous stitching.

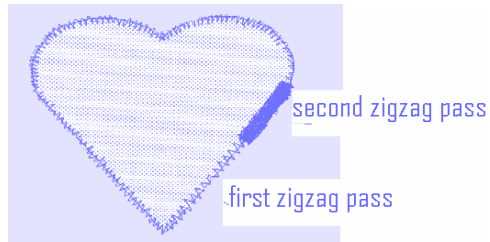

- ◆ Sewing over an applique twice is not always necessary, however, it does give a beautiful full-covered effect.

Lace Insertion



Insert lace into a special occasion garment or a home decorating project to create a beautiful heirloom keepsake.

Machine Set-Up:

Stitch:	Zigzag stitch
Stitch Width:	2-3
Stitch Length:	1
Presser Foot:	Standard Foot or Satin Foot*
Needle Position	Center



Materials:

5" x 3" of batiste
6" strip of lace
60-80 weight fine cotton thread

Procedure:

- ◆ Spray starch and iron the lace and batiste.
- ◆ Center the lace right side up, lengthwise on batiste.
- ◆ Stitch lace to fabric by sewing a zigzag stitch down both edges of the lace. Try to just clear the heading on the lace.

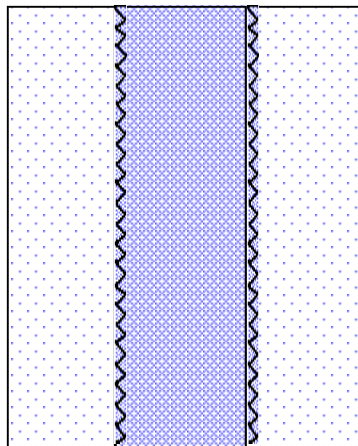

*Depending on model, the Satin Foot might be optional. Check the instruction manual.

- ◆ Carefully cut under the lace down the center.

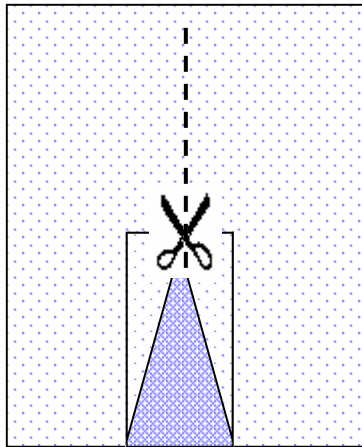

- ◆ Turn these raw edges back away from the lace, then finger press.
- ◆ Finish fabric's edges by sewing a small zigzag through all layers, being careful not to catch too much lace.
- ◆ Turn fabric over and trim excess fabric seam allowances away.

Note: A nice touch can be added by Hemstitching down each side of the lace.

Couching a Strand of Pearls



Couching is a term for sewing over trims, such as cord, ribbon or a strand of pearls. The stitch may or may not penetrate the cord it stitches over, depending on the desired effect. A Zigzag stitch or a wide decorative stitch are excellent choices for this technique.

Machine Set-Up:

Stitch:	Zigzag
Stitch Width:	Adjust according to size of pearls
Stitch Length:	3 or 4
Presser Foot:	Standard Foot



Materials:

Monofilament thread
Strand of pearls
Felt or stabilized woven fabric

Procedure:

- ◆ Lay pearls or other couching trim on top of fabric.
- ◆ Stitch, adjusting width to ensure the stitch slightly encases the trim as desired.



Button Sewing



Use your sewing machine to sew on buttons, snaps or hooks with ease. This is especially helpful when making a large project where multiple buttons need to be attached, such as a shower curtain that has button tabs.

Machine Set-Up:

Stitch: Zigzag
Stitch Width: Determined by button
(width between holes is usually 3mm)
Stitch Length: N/A
Feed Dogs: Lowered (or Covered) Position
Presser Foot: Button Sewing Foot*

Materials:

Home décor fabric or shirting
One 2-hole button
Liquid fray preventer



Procedure:

- ◆ Lower the Feed Dogs or Cover them with the Feed Dog Cover. (see your manual for more information)
- ◆ Fold fabric in half and place under foot.
- ◆ Position the button on the fabric so that the holes in the button are between the toes of the foot.

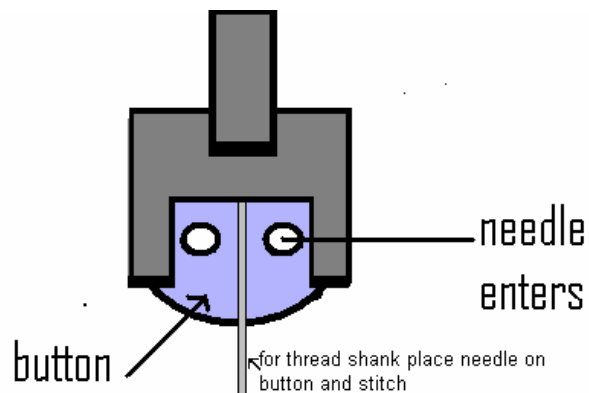

- ◆ Lower the presser foot to hold the button in place.
- ◆ Turn the hand wheel forward, adjust so that the needle goes into the right or left hole.
- ◆ Adjust the stitch width dial to fine tune the swing of the needle into the opposite hole.
- ◆ Recheck the swing of the needle into the other hole, and then use the foot control to sew 5-6 stitches.
- ◆ Before removing the button and fabric from the machine, turn to straight stitch. Leave width at current setting and stitch in place for three stitches. This forms a tie-off on the back side to secure the button.
- ◆ Apply a liquid fray-preventer on the backside of fabric on the knots. Trim threads after they dry, being careful not to cut thread knots.

Note: Remember to raise the feed dogs (or remove the feed dog cover) when finished.

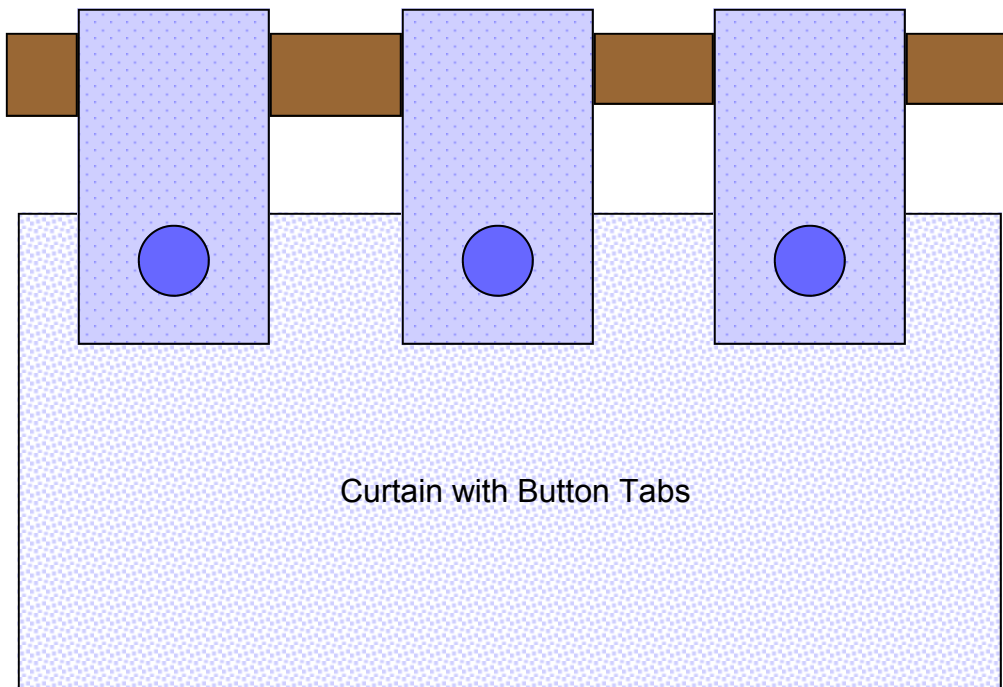

Four-Step Buttonholes



The built-in buttonhole is divided into four different steps. This simple process provides reliable results for buttonholes on garments, home decorating projects and crafts.

Machine Set-Up:

Stitch:	Step One of the 4-Step Buttonhole*
Stitch Width:	Buttonhole symbol
Stitch Length:	Buttonhole symbol
Presser Foot:	Buttonhole Foot
Needle Position:	Changes automatically

(See manual for complete machine set-up for buttonholes.)

Materials:

Home décor fabric with interfacing or tear-away stabilizer
Disappearing fabric marking pen or tailor chalk (for marking size of buttonhole)
Button (to establish length of buttonhole)
Liquid fray preventer

Procedure:

- ◆ Fold fabric in half crosswise, with interfacing or stabilizer placed between layers.

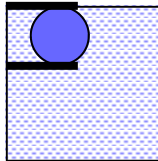

- ◆ Lay button on fabric and mark the top and bottom of the button. This will establish the starting and ending point of the buttonhole.

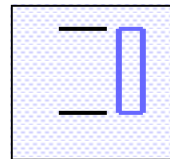
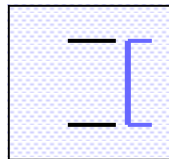
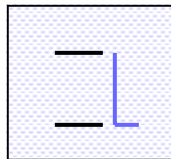
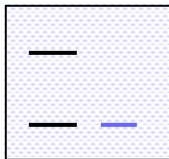

- ◆ Place the fabric under the foot, matching the foot's red mark with the bottom mark on the fabric.

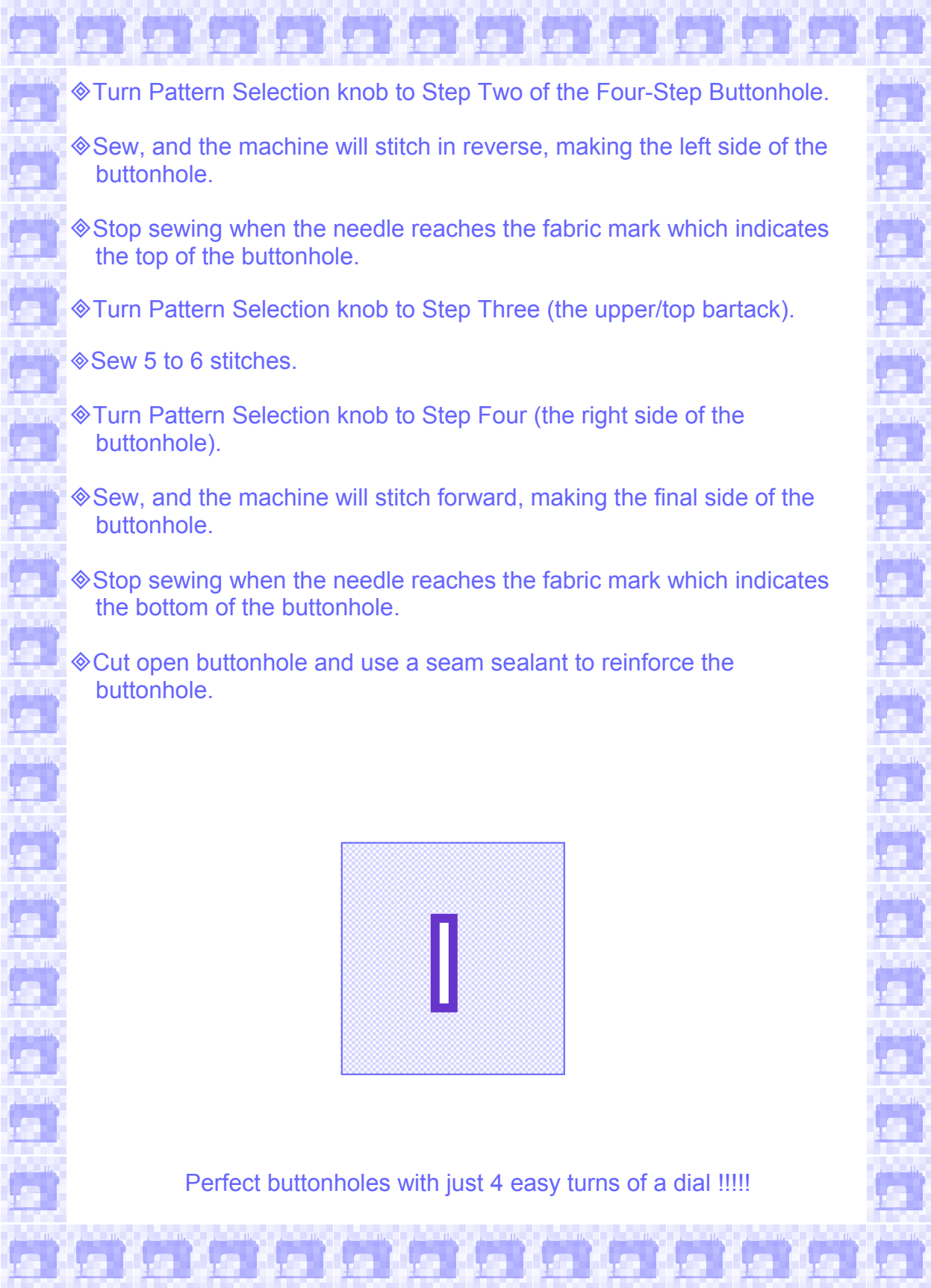
- 
- ◆ Turn Pattern Selection knob to Step Two of the Four-Step Buttonhole.
 - ◆ Sew, and the machine will stitch in reverse, making the left side of the buttonhole.
 - ◆ Stop sewing when the needle reaches the fabric mark which indicates the top of the buttonhole.
 - ◆ Turn Pattern Selection knob to Step Three (the upper/top bartack).
 - ◆ Sew 5 to 6 stitches.
 - ◆ Turn Pattern Selection knob to Step Four (the right side of the buttonhole).
 - ◆ Sew, and the machine will stitch forward, making the final side of the buttonhole.
 - ◆ Stop sewing when the needle reaches the fabric mark which indicates the bottom of the buttonhole.
 - ◆ Cut open buttonhole and use a seam sealant to reinforce the buttonhole.

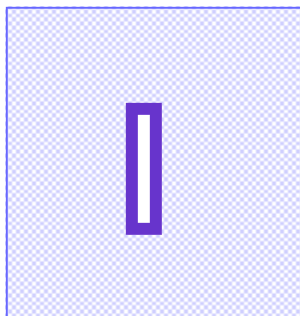

Perfect buttonholes with just 4 easy turns of a dial !!!!!

One-Step Buttonholes



The built-in One-Step Buttonhole* measures the button's length and then automatically sews a beautiful buttonhole. This is a very simple process that provides reliable results on garments, home decorating projects and crafts.

Machine Set-Up:

Stitch:	Buttonhole symbol
Stitch Width:	Buttonhole symbol
Stitch Length:	Buttonhole symbol
Presser Foot:	Buttonhole Foot

(see manual for complete machine set-up for buttonholes)

Materials:

Home décor fabric with interfacing or tear-away stabilizer
Disappearing marking pen or tailor chalk (for marking start of buttonhole)
Button (to establish length of buttonhole)

Procedure:

- ◆ Fold fabric half crosswise, with interfacing or stabilizer between layers.
- ◆ Make a mark with the disappearing marking pen to indicate where the bottom or first bar tack should be sewn.
- ◆ Open the Button Plate and insert the button.
- ◆ Lower the Buttonhole Lever and gently push it back.

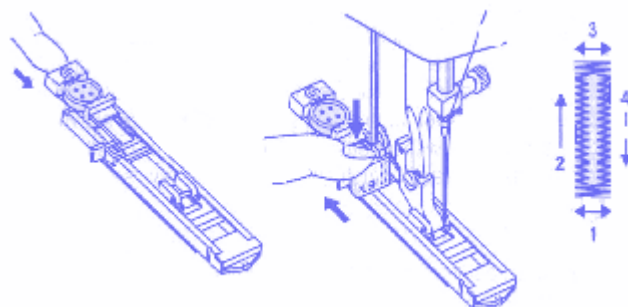

* This feature is only available on certain models. Check the instruction manual.

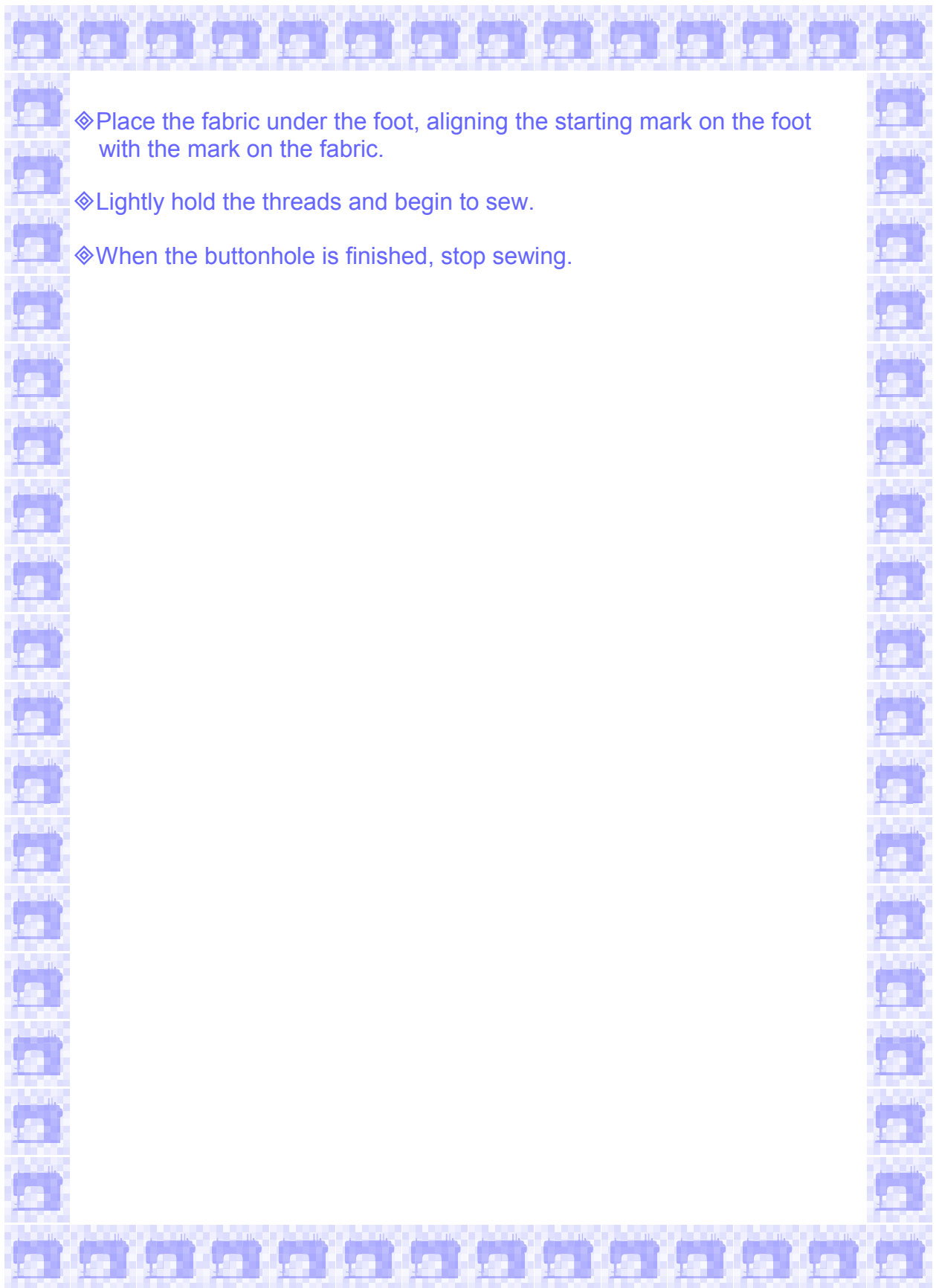

- ◆ Place the fabric under the foot, aligning the starting mark on the foot with the mark on the fabric.
- ◆ Lightly hold the threads and begin to sew.
- ◆ When the buttonhole is finished, stop sewing.

Four-Step Corded Buttonholes

A Corded Buttonhole adds strength and stability. This type of buttonhole is especially important when sewing stretch fabrics or fabrics that easily ravel. The “cord” can be a heavy thread, several strands of regular thread or lightweight yarns, etc. The buttonhole is stitched over the cord, creating a reinforced buttonhole.

Machine Set-Up:

Stitch:	Step 1 of the Four-Step Buttonhole*
Stitch Width:	Buttonhole symbol
Stitch Length:	Buttonhole symbol
Presser Foot:	Buttonhole Foot

(See manual for complete machine set-up for buttonholes.)

Materials:

Home décor fabric with interfacing or tear-away stabilizer
Disappearing marking pen or tailor chalk (for marking size of buttonhole)
Button (to establish length of buttonhole)
8” piece of cord

Procedure:

- ◆ Hook or loop the cord around the small extension at the end of the buttonhole foot.
- ◆ Bring both ends of the cord under the foot and hold them taut. Tie the cords to secure them.
- ◆ Attach the Buttonhole Foot to the machine, taking care not to displace the cord. (See sewing machine instruction manual)
- ◆ The foot will hold the cord in the correct position as the machine stitches the buttonhole.
- ◆ Sew the buttonhole, following the Four-Step Buttonhole instructions.

*This technique applies to machine models featuring the Four-Step Buttonhole.

- ◆ The zigzag section of the buttonhole will stitch over the cord.
- ◆ After stitching is completed, pull the excess cord tails tight. This will pull the cord into the buttonhole.
- ◆ Cut off the excess cord.

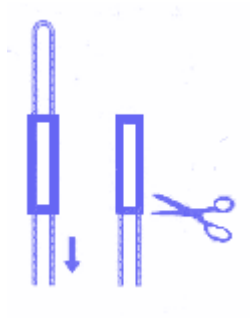

One-Step Corded Buttonholes

A Corded Buttonhole provides added strength and stability to buttonholes. This type of buttonhole is especially important when sewing stretch fabrics or fabrics that easily ravel. The “cord” can be a heavy thread or several strands of regular thread. The buttonhole is stitched over the cord, creating a reinforced buttonhole.

Machine Set-Up:

Stitch:	Buttonhole symbol*
Stitch Width:	Buttonhole symbol
Stitch Length:	Buttonhole symbol
Presser Foot:	Buttonhole Foot

(See manual for complete machine set-up for buttonholes.)

Materials:

Knit fabric with interfacing or tear-away stabilizer
Disappearing marking pen or tailor chalk (for marking start of buttonhole)
Button (to establish length of buttonhole)
8” piece of cord

Procedure:

- ◆ Hook or loop the cord around the small extension at the back end of the buttonhole foot.
- ◆ Bring both ends of the cord under the foot and pull them forward. Tie the cords to secure them.

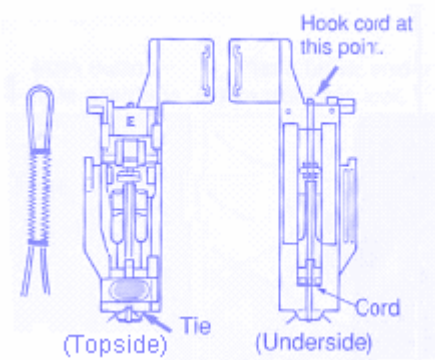

*This technique applies to machine models featuring the One-Step Buttonhole.

- ◆ Attach the Buttonhole Foot to the machine, taking care not to displace the cord. (See sewing machine instruction manual)
- ◆ The foot will hold the cord in the correct position as the machine stitches the buttonhole.
- ◆ Sew the buttonhole, following the One-Step Buttonhole instructions in the machine instruction manual.
- ◆ The zigzag section of the buttonhole will stitch over the cord.
- ◆ After stitching is completed, pull the excess cord tails tight. This will pull the cord into the buttonhole.
- ◆ Cut off the excess cord.

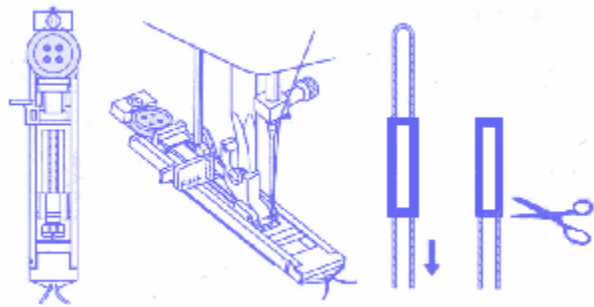

Free-Motion Monogramming



Monogramming adds a personal and professional touch to garments, home decorating items and craft projects. When monogramming, the feed dogs are lowered (or covered), allowing for free-motion sewing.

Machine Set-Up:

Stitch:	Zigzag Stitch
Stitch Width:	2
Stitch Length:	N/A
Feed Dogs:	Lowered
Presser Foot:	Embroidery/Darning Foot* or remove the foot completely



Materials:

Embroidery hoop
8" x 8" Cotton with an iron-on interfacing
Fabric marking pen

Procedure:

- ◆ Using the fabric marking pen, draw the desired monogram letter.
- ◆ Place fabric in the embroidery hoop, making sure the fabric is taut.
- ◆ Place the hoop under the foot, positioning the needle over the starting point of the monogram.
- ◆ Lower the presser foot.



*Depending on model the Embroidery/Darning Foot might be optional. Check the instruction manual.

- 
- ◆ Turn the hand wheel forward to bring up the bobbin thread through the fabric. Sew a few securing stitches at the starting point.
 - ◆ Firmly hold the hoop with both hands.
 - ◆ Press the foot controller and guide the hoop so that the needle stitches on the drawn letter.
 - ◆ Maintain a consistent sewing speed and move the fabric slowly. Coordinate sewing speed and movement of hoop.

Note: When the feed dogs are lower (or covered) the fabric will not automatically feed. Feeding of fabric is controlled manually.

Free-Motion Embroidery



Free-motion embroidery is an elegant embellishment. The embroidery can be extremely detailed, such as the embroidery on a bridal gown. It can also be as simple as a row of flowers on kitchen linens.

Machine Set-Up:

Stitch:	Zigzag Stitch
Stitch Width:	2 or smaller
Stitch Length:	N/A
Foot Dogs:	Lowered
Presser Foot:	Embroidery/Darning Foot* or remove the foot completely



Materials:

Embroidery hoop
8" x 8" Cotton with an iron-on interfacing
Fabric marking pen

Procedure:

- ◆ Using the fabric marking pen, draw the desired design or trace a simple design.
- ◆ Place fabric in the embroidery hoop, making sure the fabric is taut.
- ◆ Place the hoop under the foot, positioning the needle over the starting point of the design.
- ◆ Lower the presser foot.
- ◆ Turn the hand wheel forward to bring up the bobbin thread through the fabric. Sew a few securing stitches at the starting point.



*Depending on model, the Embroidery/Darning Foot might be optional. Check the instruction manual.

- 
- ◆ Firmly hold the hoop with both hands.
 - ◆ Press the foot controller and guide the hoop so that the needle stitches on the drawn letter.
 - ◆ Maintain a consistent sewing speed and move the fabric slowly. Coordinate sewing speed and movement of hoop.

Note: When the feed dogs are lower or dropped the fabric will not automatically feed. Feeding the fabric is controlled manually.

Blind Hem



A Blind Hem is a fast way to finish hems securely on skirts or pants. It also makes a great choice when hemming large projects such as curtains or bed skirts. Use matching thread to help the stitches blend into the fabric, hence becoming “blind” or invisible.

Machine Set-Up:

Set-up for Step 1 (to finish raw edges)

Stitch:	Zigzag
Stitch Length:	1.0
Stitch Width:	5
Presser Foot:	Standard Foot

Set-up for Step 2 (to baste the fold)

Stitch:	Straight Stitch
Stitch Length:	4
Stitch Width:	0
Tension Dial:	2
Presser Foot:	Standard Foot

Set-up for Step 3 (to create the hem)

Stitch:	Blindhem
Stitch Length:	2-3
Stitch Width:	3-4
Tension Dial:	2
Presser Foot:	Blindhem Foot*

Materials:

Medium weight woven fabric

Procedure:

◆ Sew a Zigzag to finish one of the fabric’s raw edges.

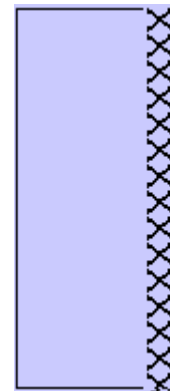

◆ Fold under 1" and baste in place.

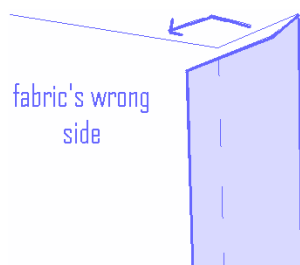

◆ Position fabric with wrong side facing up, and turn the hem back to the right side, creating a soft fold at the top edge of the hem. The bulk of the fabric is to the left of the foot.

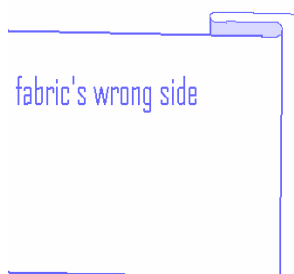

◆ Begin stitching, making sure the forward stitches fall near the 1/4" fold, and the needle swing just bites into the fold, catching only 2 or 3 threads.

Note: Always use matching thread to help "hide" the stitches.

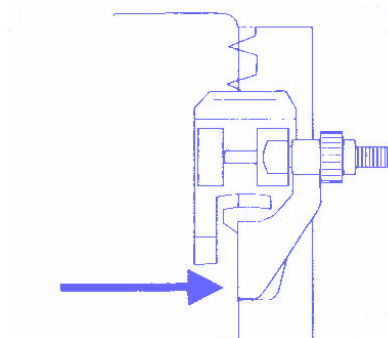

*Depending on model, the Blindhem Foot might be optional. Check the instruction manual.

Attaching Beaded Trims



Adding a trim is an easy way to enhance almost any project! The “look” of a denim jacket can be changed with a row of trim around the bottom edge. A pair of capri pants can be dressed up by sewing a beaded trim around each pant hem. Home decorating projects such as pillows, bedspreads or table runners can have a “face-lift” by just adding a beaded trim.

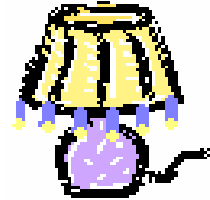

Machine Set-Up:

Stitch: Multi-Mending
Stitch Width: 5-7
Stitch Length: 3
Presser Foot: Standard Foot

Materials:

Beaded trim
Home Décor fabric

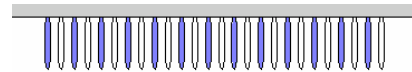

Procedure:

- ◆ Press and stitch a 1” hem in the fabric, using a straight stitch.
- ◆ Place fabric on machine with wrong side facing up.
- ◆ Place trim header on fabric’s edge, right side facing down.
- ◆ Stitch on the the trim’s header.

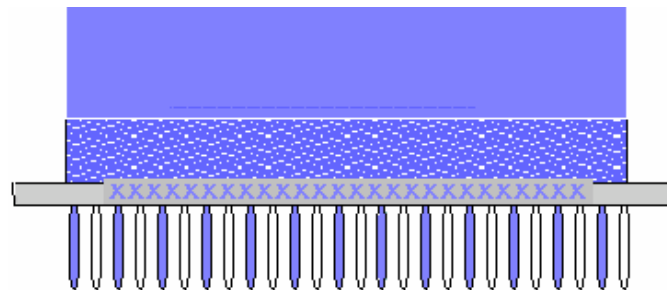

Mending with Multi-Stitch Zigzag

The Multi-stitch is a three-step zigzag stitch. It is stronger than a traditional zigzag stitch and is used for mending, reinforcing a stitch, darning, applying elastic and many other techniques. It is ideal when mending tears.

Machine Set-Up:

Stitch:	Multi-Stitch
Stitch Width:	5-7
Stitch Length:	1
Presser Foot:	Standard Foot



Materials:

2" x 2" denim square
5" x 5" denim, cut a 1" tear in center of denim

Procedure:

- ◆ Use the small denim square as a backing to add reinforcement.
- ◆ Stitch directly over the tear; pivot 180 degrees and sew again.

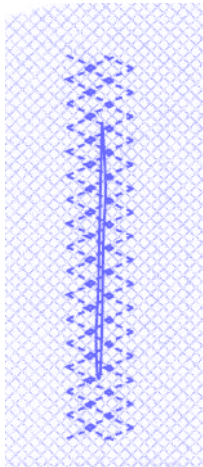

Crazy Quilting



Crazy quilting is done by stitching scraps of velvets, silks, satins, and other fine fabrics onto a foundation fabric. The fabrics are various shapes. The seams are then embellished with decorative stitches, often done with decorative threads. This technique is popular and can be used in wearable art, home decorator projects and more.

Machine Set-Up:

Stitch: Any Decorative Stitch
Stitch Width: Adjust according to preference
Stitch Length: Adjust according to preference
Presser Foot: Transparent Satin Foot or Standard Foot

Materials:

Fabric scraps
Foundation fabric or paper
Various decorative threads

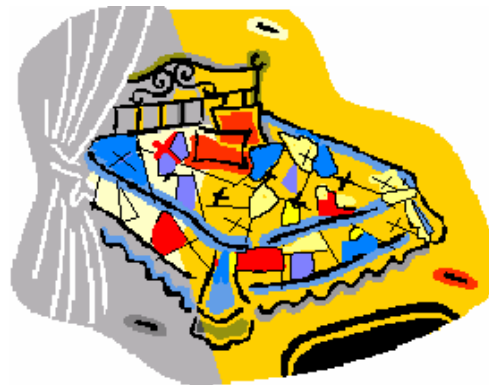

Procedure:

- ◆ Crazy-piece the scraps onto the foundation fabric or paper, starting from the center and working outward.
- ◆ Select desired decorative stitch and center the stitching over the seam lines.
- ◆ Use rayon, metallic or other decorative threads as desired.

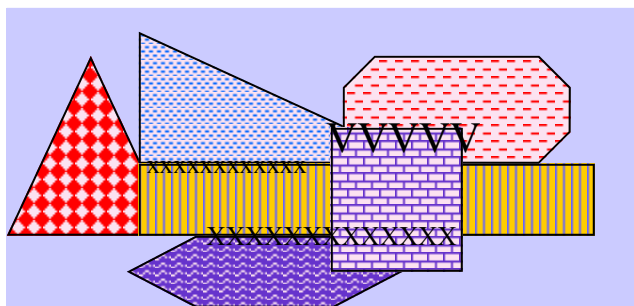

Scallop Edging



This delicate Scallop Stitch creates beautiful edging for dresses, blouses, lingerie, children's clothing, table linens and more.

Machine Set-Up:

Stitch: Scallop Stitch
Stitch Width: 7
Stitch Length: Below 1
Presser Foot: Transparent Satin Foot or Standard Foot

Materials:

Light weight fabric, such as batiste
Rinse away stabilizer
30 weight decorative thread

Procedure:

- ◆ Fold fabric in half.
- ◆ Place stabilizer under fold, extending 1" beyond fabric edge.
- ◆ Stitch a row of scallops. Align center of foot on folded edge.
- ◆ Trim away excess stabilizer, then rinse with water to remove remaining stabilizer.

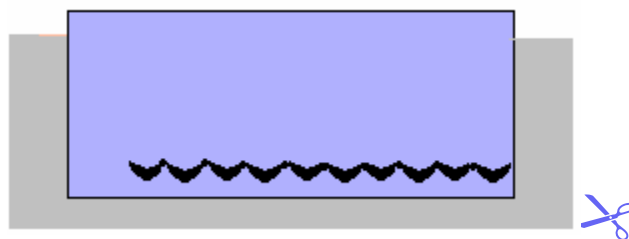

Straight Stretch Stitch for Woven Fabrics



This stitch is wonderful for built-in strength! It is ideal when sewing heavy-weight fabrics or when it is desired to have a bolder straight stitch. Try it as a topstitch on jeans, a home decorating project, or when an extra-strong seam is needed, such as children's clothing.

Machine Set-Up:

Stitch:	Triple Straight Stitch
Stitch Width:	0, no width
Stitch Length:	Stretch setting
Presser Foot:	Standard Foot

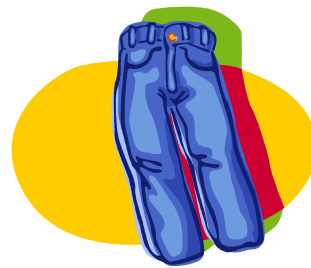

Materials:

Denim, folded in half

Procedure:

◆ Sew on the two layers.

Note: Slowly turn the handwheel and watch the needle repeat each stitch 3 times. Because the stitch repeats, it is much stronger.

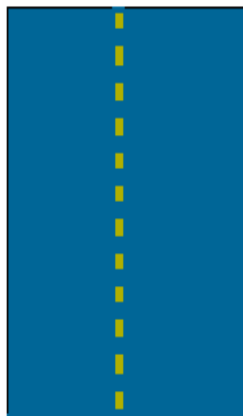

Straight Stretch Stitch for Stretch Fabrics



In the 1970's, fabrics that had stretch were introduced. Previously, only woven-type fabrics were available for home sewers. When a standard straight stitch is sewn on stretch fabric, it will "pop" or break when the fabric is stretched. Special stitches were created to allow "no-pop" sewing on stretch fabrics, and these stitches are called Stretch Stitches or Flexi-Stitches. Today, stretch fabrics are used to make exercise outfits, dance costumes, swimsuits and much more. As the fabrics of these garments stretch, so do the stitches!

Machine Set-Up:

Stitch:	Triple Straight Stitch
Stitch Width:	0, no width
Stitch Length:	Stretch Setting
Presser Foot:	Standard Foot



Materials:

Knit fabric, folded in half

Procedure:

◆ Stitch on the two layers.

Note: After sewing, notice how the stitch stretches with the fabric.



Ribbing Application



The Overedge Stretch Stitch makes sewing seams on knits look as though they were finished on a serger. This stitch is stronger and more durable than overlock/serger stitching. The stitch incorporates a straight stitch and a finishing stitch into one operation. This allows for professional finish on projects, and is especially popular on sweatshirts.



Machine Set-Up:

Stitch: Overedge Stitch
Stitch Width: 5 or 7
Stitch Length: Stretch setting
Presser Foot: Overedge Foot* or Standard Foot

Materials:

6" x 6" Medium to heavy weight knit fabric or polar fleece
3" x 6" Ribbing

Procedure:

- ◆ Cut a curve in the knit fabric to resemble a neckline.
- ◆ Fold ribbing in half lengthwise.
- ◆ Starting at the left side of the knit curve, place ribbing on front side of curve.
- ◆ Match all 3 cut edges and place under the foot.
- ◆ Line up fabric edges with guide on foot and stitch the length of the seam.

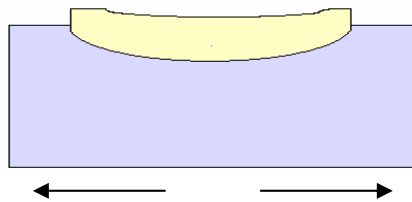

- ◆ Stretch ribbing slightly to fit the cut edge of the knit.
- ◆ When finished, lift foot and pull threads and fabric straight back behind foot and trim.

*Depending on model, the Overedge Foot might be optional. Check instruction manual.

Overedge Stitching



When joining two pieces of fabric, it is usually necessary to finish the edges. This prevents raveling of the fabric and creates a professional finish.

Machine Set-up:

Stitch: Stretch Overedge or Serge Stitch
Stitch Width: 5 or 7
Stitch Length: See manual
Presser Foot: Overedge Foot* or Standard Foot



Materials:

(2) pieces of woven fabric

Procedure:

- ◆ Right sides together, place the fabric under the foot.
- ◆ Align the fabric's edges with the foot's edge.
- ◆ Sew, joining two pieces of fabric and finishing the edges in one operation.

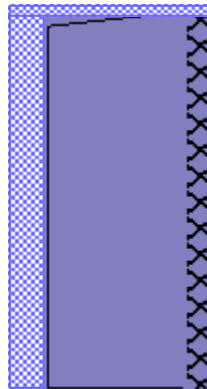

*Depending on model, the Overedge Foot might be optional. Check instruction manual.

Open Seams with Overedge Stitching



This technique is ideal for making an unlined garment when the seam allowances may show. Just like the previous technique, this also prevents raveling of the fabric and makes a professional finish on woven and knit fabrics.

Machine Set-Up:

Stitch: Stretch Overedge or Serge Stitch
Stitch Width: 5 or 7
Stitch Length: See manual
Presser Foot: Overedge Foot* or Standard Foot

Materials:

(2) 4" x 3" pieces of heavy woven fabric

Procedure:

- ◆ Place one piece of fabric under the foot, aligning the fabric edge so that the stitch forms just on the edge of the fabric.
- ◆ Place the second piece of fabric under the foot, aligning the fabric edge so that the stitch forms just on the edge of the fabric. Sew.
- ◆ Change to the Standard Foot and set the machine for a straight stitch.
- ◆ With right sides together, join the two pieces of fabric. Align the two finished edges with a 5/8" seam allowance guide.
- ◆ Open seam flat and press.

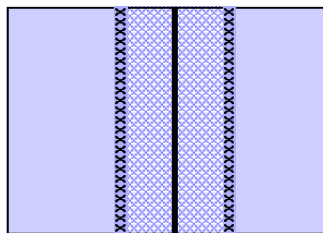

*Depending on model, the Overedge Foot might be optional. Check instruction manual.

Attaching Elastic



Elastic can be applied directly to the fabric, such as when making lingerie. If the elastic is 3/8" wide or less, the elastic can be placed into the Standard Foot's opening, making it easier to evenly stretch the elastic while sewing.

Machine Set-Up:

Stitch: Multi-Zigzag or Stretch Honeycomb Stitch
Stitch Width: 5 or 7
Stitch Length: 3 for Multi-Zigzag or Stretch setting
for Honeycomb Stitch
Presser Foot: Standard Foot

Materials:

Nylon Tricot 4" x 8"
3/8" wide elastic strip, cut 7" long

Procedure:

- ◆ Thread elastic through the needle-opening hole in the foot.
- ◆ Pull 2-3" of elastic to the back of the foot, enough to firmly grasp.
- ◆ Position fabric under the foot.
- ◆ Sew, gently pulling the elastic while sewing.

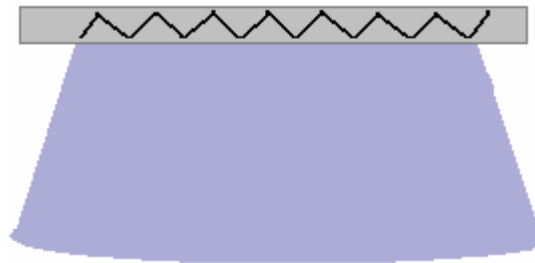

Sewing with a Wing Needle

Use a Wing Needle to create a beautiful heirloom look on pillowcases, napkins, or special occasion garments. A Wing Needle is very wide and makes a large opening or hole in the fabric every time it stitches. Several different types of stitches can be used. For best results, use a stitch with forward-back movement, so that the needle penetrates the same hole more than once.

Machine Set-Up:

Stitch: Zigzag Stitch
Stitch Width: 1
Stitch Length: 5
Presser Foot: Transparent Satin Foot or Standard Foot
Needle: Wing Needle

Materials:

Linen or other natural fiber fabric, spray-starched for added firmness
60-80 weight sewing thread
60-80 weight sewing thread in bobbin

Procedure:

- ◆ Pull one or two threads to establish a guideline for stitching.
- ◆ Stitch along the pulled threads. Notice the pronounced holes that are created by the stitching.

Note: An alternative method is to trace a design onto fabric using chalk, water-soluble or air soluble marker. (Use stencils, templates or create a design.) Stitch along the drawn lines of the design.

Twin Needle Sewing



By using a Twin Needle, two parallel rows of stitching can be sewn at the same time. A straight stitch using a twin needle sewing creates a sporty hem on knit wear, a sophisticated top-stitch or a decorative embellishment.

Machine Set-Up:

Stitch:	Straight Stitch
Stitch Width:	0, no width
Stitch Length:	5
Presser Foot:	Transparent Satin Foot or Standard Foot
Needle:	Twin Needle

Materials:

5" x 5" piece of lightweight woven fabric, with a stabilizer ironed-on

Procedure:

- ◆ Insert the second spool pin.
- ◆ Both spools of thread follow the same threading path until they reach the eye of the needle. Thread each needle separately.
- ◆ Slowly sew a row of stitching on the right side of the fabric.
- ◆ Maintain a slow consistent speed to ensure accurate stitching.

Note: When sewing with a stitch that has width (such as a zigzag or decorative stitch) and the twin needle, never set the width wider 3.0. Always test that the needle does not hit the foot by turning the hand wheel.

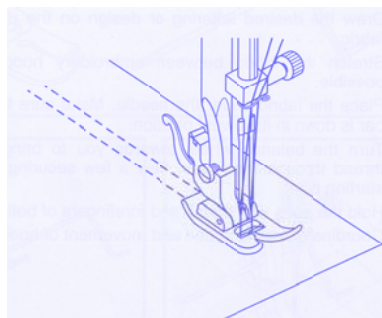

Attaching Ribbon with a Twin Needle



By using a Twin Needle, two parallel rows of stitches can be used to attach a ribbon while stitching.

Machine Set-Up:

Stitch: Straight Stitch
Stitch Width: 0, no width
Stitch Length: 5
Presser Foot: Transparent Satin Foot or Standard Foot
Needle: Twin Needle

Materials:

5" x 5" piece of lightweight woven fabric, with a stabilizer ironed-on
6" long piece of 1/4" wide satin ribbon

Procedure:

- ◆ Insert the second spool pin.
- ◆ Both spools of thread follow the same threading path until they reach the eye of the needle. Thread each needle separately.
- ◆ Insert the ribbon through the hole in the presser foot. Pull the ribbon under the foot and then to the back of the foot.
- ◆ Slowly sew a row of stitching on the right side of the fabric.
- ◆ Maintain a slow consistent speed to ensure accurate stitching.

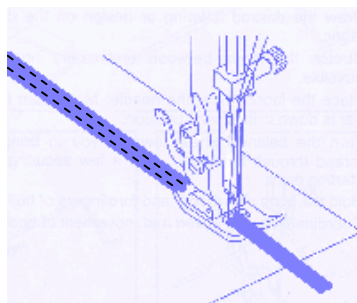

Sewing on Leather



Leather can add a bold accent to a garment, home decorating or craft project. Leather does not ravel, so there is no need to finish the seam edges.

Machine Set-Up:

Stitch: Straight Stitch
Stitch Width: 0, no width
Stitch Length: 3
Presser Foot: Transparent Satin Foot or Standard Foot
Needle: Leather Needle



Materials:

Fashion leather

Procedure:

- ◆ Finger press a 1" hem in the leather.
- ◆ Sew, using the seam guides to ensure straight stitching.

Note: A Roller Foot or Even Feed Foot feed the leather, vinyl or suede through the machine more easily.

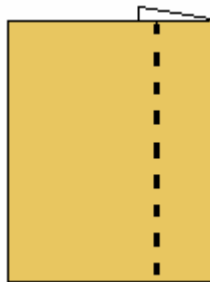

Narrow Hem



The edge of a ruffle, the hem on a napkin and the edge of a prom dress are all perfect examples of where it is beneficial to use the Rolled Hem Foot. The foot has a “scroll” that helps roll the fabric’s edge over, hiding the raw edges and creating a small professional finish hem. Soft fabrics roll best.

Machine Set-Up:

Stitch:	Straight Stitch
Stitch Width:	0, no width
Stitch Length:	3
Presser Foot:	Rolled or Narrow Hem Foot*

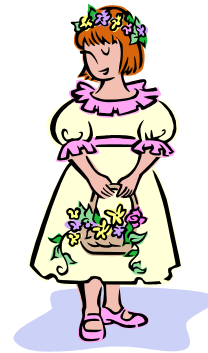

Materials:

Medium to light weight fabric

Procedure:

- ◆ Press a 1/8” hem to approximately 1 inch of the fabric’s edge.
- ◆ Stitch the small hem into place with a straight stitch.
- ◆ Leave the needle in the fabric, but lift the presser foot.
- ◆ Guide the fabric into the scroll of the foot.
- ◆ Lower foot and continue to sew, holding the thread tails firmly.
- ◆ Hold fabric taut and slightly up to help the fabric to “roll” into the scroll.

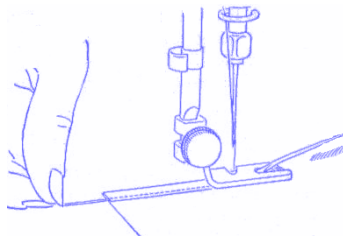

*Depending on model, the Rolled/Narrow Foot might be optional. Check the instruction manual.

Gathering with the Cording Foot

This technique is great for heavy fabrics such as in home decorating or textured fabrics that do not gather easily. The Cording Foot holds the cord in place so it is effortless to sew over the cord. Adjusting gathers is easy, and there is no danger that the cord will break in the middle of the project.

Machine Set-Up:

Stitch: Zigzag
Stitch Width: 3
Stitch Length: 3
Presser Foot: Cording Foot*



Materials:

10" long strand of cotton or fine cord
Home Décor fabric

Procedure:

- ◆ Place a single cord in the center groove of the foot.
- ◆ Secure the cord by tying a knot at the back of the foot.
- ◆ Place the fabric under the foot.
- ◆ Sew a test to ensure that the Zigzag stitches are sewing over the cord, not into the cord. The Zigzag stitch is making a casing for the cord.
- ◆ After stitching is finished, pull the cord which will draw up or gather the fabric.
- ◆ Adjust the gathers evenly by sliding the fabric along the cord.
- ◆ Sew a straight stitch to secure the gathers into place.

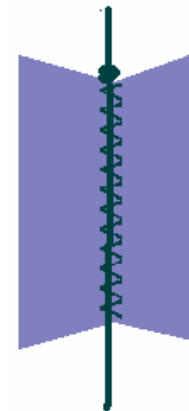

*Depending on model, the Cording Foot might be optional. Check the instruction manual.

Applying Trims, Cords or Braids

Use the Cording Foot to easily apply thin cords to add textured to wearable art fashions or home decorating projects. The foot holds the cords in place so that it is effortless to stitch them into place. There are several decorative cords available, each creating a different effect. Experiment with various cords and stitches!

Machine Set-Up:

Stitch:	Multi-Zigzag
Stitch Width:	3
Stitch Length:	3
Presser Foot:	Cording Foot*



Materials:

Three strands of thin cording
Home Décor fabric

Procedure:

- ◆ Thread one decorative cord through each of the foot's three grooves or slots.
- ◆ Secure the three cords at the back of the foot by tying a knot.
- ◆ Place the fabric under the foot and sew.
- ◆ The foot will hold all the cords in place as they are sewn to the fabric.

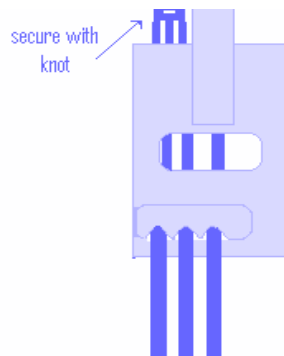

*Depending on model, the Cording Foot might be optional. Check the instruction manual.

Shirring with the Gathering Foot



Gathering fabric means to draw the fabric up on a thread to create fullness. Shirring consists of three or more rows of gathers. Use only sheer or soft fabrics for this technique. The specially designed Shirring Foot pushes fabric into even folds under the needle. The stitch then holds the fabric folds securely.

Machine Set-Up:

Stitch:	Straight Stitch
Stitch Width:	0, no width
Stitch Length:	5 or 7
Tension:	Fullness is regulated by stitch length Increase the tension
Presser Foot:	Gathering Foot*

Materials:

Lightweight fabric, such as batiste

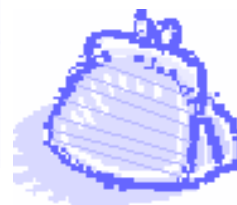
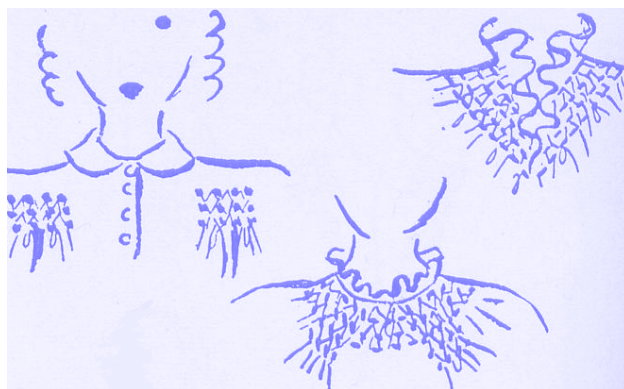

Procedure:

- ◆ Pull one to two threads on the fabric's crosswise grain, to create a straight stitching line.

*Depending on model, the Gathering Foot might be optional. Check the instruction manual.

- ◆ Turn the handwheel to ensure the needle is correctly positioned. It should line up with the Gathering Foot's needle opening.
- ◆ Sew a row on top of the "pulled" line.
- ◆ Use the foot's edge as a guide to sew the next row of stitching. Rows will be 1/4" apart if the foot is used as a guide.

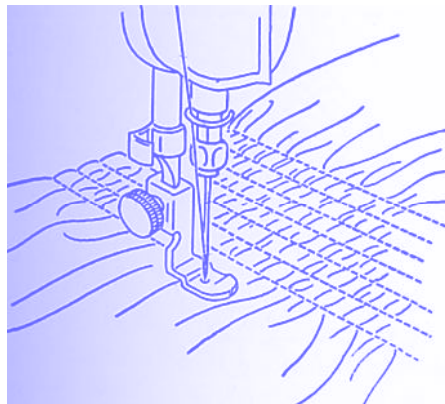

- ◆ Sew 3 or 4 more rows.
- ◆ Do not clip thread ends until it is determined if any fine adjustments are needed to make the gathers even-looking.



Sewing with an Even Feed Foot

The Even Feed Foot has its own set of feed dogs that work in conjunction with the machine's feeding system to improve the flow of the fabric. This is particularly important when sewing several layers of fabric, such as in quilting. The Even Feed Foot "pulls" the top layer or layers of fabric through at the same speed as the machine's feed dogs are pulling the bottom layer or layers of fabric, providing for more even feeding!

Machine Set-Up:

Stitch:	Straight Stitch
Stitch Width:	0, no width
Stitch Length:	3
Presser Foot:	Even Feed Foot*

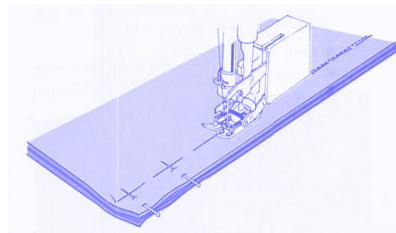

Materials:

(2) 5" x 5" pieces of cotton with batting between the two pieces

Procedure:

◆ Sew from one edge to the other.

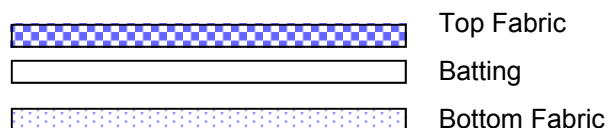

*Depending on model, the Even Feed Foot might be optional. Check the instruction manual.

Sewing with an Even Feed Foot on Plaids



Machine Set-Up:

Stitch: Straight Stitch
Stitch Width: 0, no width
Stitch Length: 3
Presser Foot: Even Feed Foot*

Materials:

(2) 5" x 5" pieces of plaid or striped fabric

Procedure:

- ◆ Match plaids, right sides together.
- ◆ Sew the two pieces together using the built-in seam guide on the machine to maintain a consistent seam allowance.

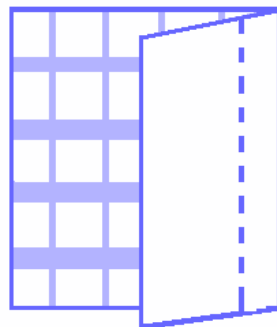

*Depending on model, the Even Feed Foot might be optional. Check the instruction manual.

Sewing with an Even Feed Foot on Pile Fabrics

The Even Feed Foot is great for sewing on fake fur for coat accents, costumes or stuffed animals.

Machine Set-Up:

Stitch:	Straight Stitch
Stitch Width:	no width
Stitch Length:	3
Presser Foot:	Even Feed Foot*

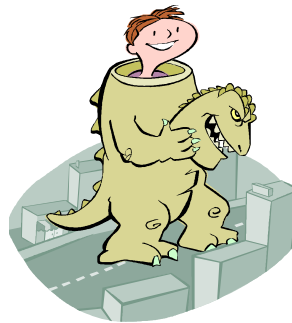

Materials:

(2) 5" x 5" pieces of fake-fur

Procedure:

- ◆ Sew the two pieces together using the built-in seam guide on the machine to maintain a consistent seam allowance.
- ◆ Push the fur into the seam.

* Depending on model, the Even Feed Foot might be optional. Check the instruction manual.

Sewing with the Side Cutter



The side cutter is an attachment that will trim the excess fabric while sewing. A Zigzag-type stitch must be used.

Machine Set-Up:

Stitch: Zigzag, Sew and Serge, or Stretch Overedge
Stitch Width: 7
Stitch Length: 1 (for Zigzag)
"S" (for Stretch Stitches)
Presser Foot: Side Cutter*



Materials:

(2) 5" x 4" pieces of wool type fabric



Procedure:

- ◆ Cut a 1" x 1" notch in the fabric.
The cutter's blades "cut" before the needle stitches. Be sure to position fabric under the needle before beginning to sew.
- ◆ Place the fabric OVER the first metal platform and UNDER the second metal platform. If the cutter is not cutting it is usually due to the fabric not being placed OVER the first platform.

View: Looking down at cutter

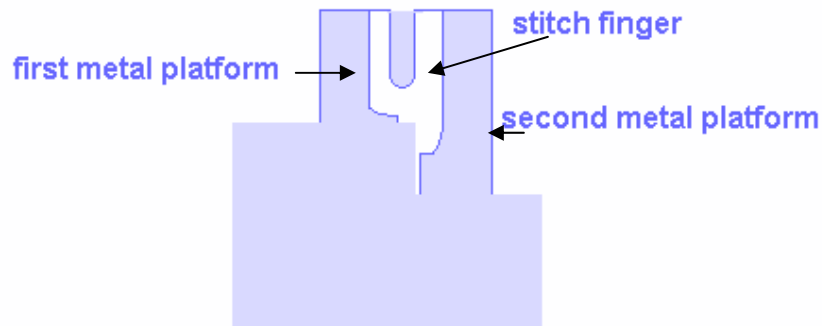

- ◆ Turn the hand-wheel to ensure the the needle does not hit the stitch finger. The stitch width may need to be adjusted.

*Depending on model, the Side Cutter might be optional. Check the instruction manual.

- ◆ Slowly sew and gently guide the fabric.
- ◆ Adjust the stitch length according to fabric. Certain fabrics will cut better or cleaner than others. This is due to the nature of the fabric.
- ◆ The cutter works best if not more than 1" is being trimmed away.

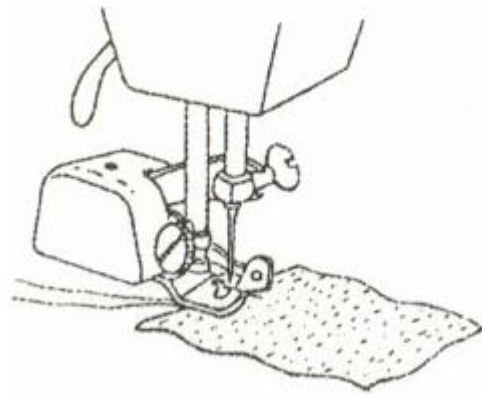

Sewing with the Ruffler



The Ruffler attachment quickly and easily produces professional looking ruffles on garments, home decorating projects and craft items.

Machine Set-Up:

Stitch: Straight Stitch
Stitch Width: 0, no width
Stitch Length: 7
Presser Foot: Ruffler

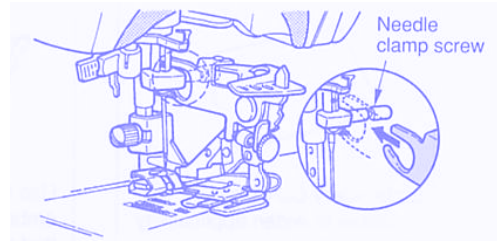

Materials:

3" x 10" piece of lightweight cotton
3" x 5" piece of lightweight cotton

Procedure:

◆ Set the Ruffler for the desired amount of "ruffles".

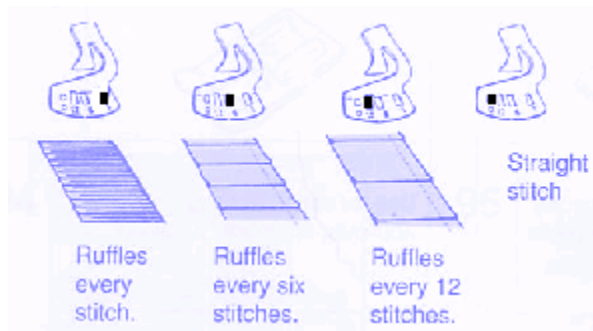

◆ Set the Ruffler for the desired depth of the ruffles.

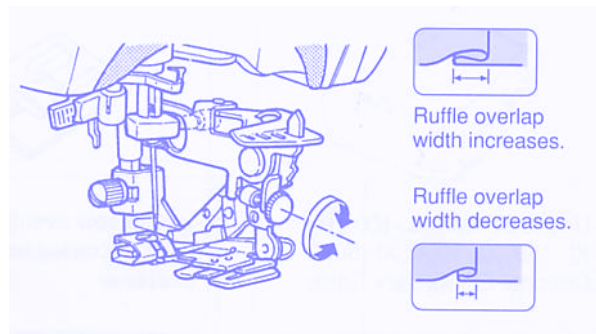

- ◆ Place the fabric under the Ruffler. Place fabric in the guide plate.



- ◆ Remember to lower the Presser Foot Lever.
- ◆ Lightly push the cloth feed plate towards the back of the machine.

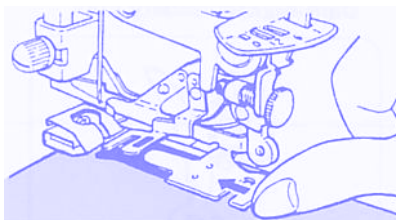

- ◆ Place the longer piece of fabric under the foot and beneath the shorter piece of fabric. Place right sides together.
- ◆ Slowly sew. Watch the Ruffler feed the fabric to make even ruffles. The bottom fabric will feed slower than the top piece.

