

SINGER®



MODEL CG-590

COMMERCIAL GRADE SEWING MACHINE WORKBOOK

SINGER®

Congratulations on the purchase of your new SINGER® Sewing Machine! This commercial grade sewing machine is ideal for all types of sewing, including fashion sewing, home decorating, quilting and crafts. Your machine is designed to deliver the ultimate combination of power, performance and durability.

This workbook has been created as a tool for learning various sewing techniques, which you can apply to your own projects. We are certain that your creativity will be inspired, and that you will have many hours of sewing enjoyment with this easy-to-use machine, feature-packed machine!

Enjoy!

The SINGER® Education Department

SINGER® is a registered trademark of the Singer Company Ltd.
© 2004 Singer Sewing Company
All Rights Reserved.
Part # 640 5052550GM

Table of Contents

| | |
|--|----|
| Straight Stitch | 1 |
| Straight Stitch for Topstitching | 2 |
| Create Quilted Fabric | 3 |
| Speed Basting | 4 |
| Making Piping | 5 |
| Attaching Purchased Piping | 6 |
| Centered Zippers | 7 |
| Satin Stitch Applique | 9 |
| Lace Insertion | 11 |
| Button Sewing | 13 |
| Four-Step Buttonholes | 15 |
| Free-Motion Monogramming | 17 |
| Free-Motion Embroidery | 19 |
| Blindstitch Hem | 21 |
| Attaching Beaded Trims | 23 |
| Mending with Multi-Stitch Zigzag | 24 |
| Crazy Quilting | 25 |
| Straight Stretch Stitch for Woven Fabrics | 26 |
| Straight Stretch Stitch for Stretch Fabrics | 27 |
| Ribbing Application | 28 |
| Overedge Stitching | 29 |
| Seam Allowance with Stretch Overedge Seam Stitch | 30 |
| Attaching Elastic | 31 |
| Sewing with a Wing Needle | 32 |
| Twin Needle Sewing | 33 |
| Applying Ribbon with a Twin Needle | 34 |
| Sewing on Leather | 35 |

| | |
|--|----|
| Decorative Stitching | 36 |
| Joining Fabric with Herringbone Stitch | 37 |
| Decorative Stippling | 38 |
| Scallop Edges | 39 |
| Narrow Hem | 40 |
| Gathering with the Cording Foot | 41 |
| Applying Trims, Cords & Braids | 42 |
| Shirring with the Gathering Foot | 43 |
| Using the Even Feed Foot to Sew Multiple Fabric Layers | 45 |
| Using the Even Feed Foot to Sew Plaid Fabrics | 46 |
| Using the Even Feed Foot to Sew Pile Fabrics | 47 |
| Sewing with the Side Cutter | 48 |
| Sewing with the Ruffler | 50 |



SINGER®

Heavy Duty Commercial Grade CG-590

| | |
|---|---|
| Up to 1100 Stitches-Per-Minute Sewing Speed | Machine sews faster than a standard sewing machine. |
| Electronic Foot Control | Guarantees consistent speed with no jump starts. Includes a regulating dial that allows for slower speeds, regardless of the pressure applied. |
| 60% Stronger Motor | The motor is stronger than a standard sewing machine motor, which means it can sew heavyweight fabrics with ease. |
| Steel Plate on Machine Bed | Sewing pins won't damage the steel surface of the machine free arm. This feature is particularly beneficial for quilting. |
| Duratec™ Frame | A SINGER® Exclusive. This provides rigid support and helps prevent rusting. |
| Double Insulated | Double insulation protects against electric shock by creating a non-conducting barrier between the operator and the electrical components inside. |
| Finger Guard | Provides additional protection to keep fingers from getting too close to the needle area. This is especially helpful and desirable for high speed sewing. |
| Free Arm | Provides professional results and easy access to cuffs, collars, pant hems and other difficult-to-reach areas. |
| Automatic Needle Threader | Effortless threading of the machine, including the eye of the needle. |
| Drop Feed | By moving the drop feed lever, conveniently located in the front of the machine, the feed dogs lower for free motion embroidery, stippling, or attaching a button. No plates or covers required, just push a lever. |
| Utility Stitches | A variety of stitches for fashion sewing, home dec and quilting. |
| Stretch Stitches | Specially designed stitches that add strength and flexibility to seams, especially useful when sewing on knitwear and super-stretch fabrics. |
| Additional Decorative and Stretch Stitches | An extensive variety of stitches for fabric embellishment, quilting, and more. |
| 6mm Stitch Width | Most stitches can be set for a maximum width of 6mm. |

| | |
|--|---|
| Touch-N-Wind™ Declutch Bobbin Winder | Needle bar easily disengages for winding the bobbin. |
| Automatic Built-In Four Step Buttonhole | Buttonhole sewing is a 4-step simple process that provides reliable results. |
| Balance Adjustment Dial | Guarantees control for even stitching of buttonholes and stretch stitches, even on difficult fabrics. |
| Infinitely Variable Stitch Length and Width Adjustment | Settings for length and width can be adjusted as desired, to suit any project. |
| Multiple Needle Positions | Needle position can be changed for individual projects, such as inserting zippers or cording and topstitching. |
| Jam-Resistant Bobbin System | This is a system in which the bobbin case actually floats above the hook, precluding thread jams. The machine will not jam, even when sewing on sheer fabric or no fabric at all! |
| Top-Loading Drop-In Bobbin | The bobbin conveniently inserts-no bobbin cases to remove or adjust. It is easy to monitor the thread supply. |
| Extra-High Presser Foot Lifter | There are 2 heights to the presser foot lifter. The second height offers ¼" more clearance, which is needed when placing multiple layers of bulky fabric under the presser foot. |
| Thread Cutter | Located for precise thread cutting, eliminating the extra step of cutting thread with scissors. |
| Automatic Pressure System | This feature automatically adjusts the pressure for sewing on fabrics from the lightest weight tricots to the heaviest denim, to maximize feed accuracy. |
| Twin Needle Capable | Stitches are automatically adjusted for twin needle sewing by just moving a lever. |
| Suction Cup Machine Base | Holds the machine securely to the table, even when sewing at maximum speed. |
| Built In Accessory Storage | A back panel storage area for accessories is conveniently located in the freearm extension bed. |
| Accessories | Special Purpose Presser Foot Buttonhole Presser Foot Blindstitch Hem Presser Foot Zipper Foot General Purpose Foot Finger Guard Needle Pack Bobbins |

| | |
|--|--|
| Self-Lubricating | Because the machine is permanently lubricated, there is no need to oil the machine, and no oil gets on fabric. |
| 25 Year Limited Commercial, School and Home Warranty | Peace of mind knowing the machine has a 25 year limited warranty. |
| Portable | Machine has a built-in carry handle, making it easy to transport the machine. |
| Cabinet Mountable | Machine can be mounted into a cabinet. |



SINGER® is a registered trademark of the Singer Company Ltd.
© 2004 Singer Sewing Company.
All Rights Reserved.

Straight Stitching

The Straight Stitch is generally used to join seams or do topstitching. It is the most basic of the stitches and is the most commonly used. For a longer stitch or for thicker fabrics, lengthen the Stitch Length.

Machine Set-Up:

Stitch: Straight Stitch
Pattern Selector: A
Stitch Width: 1, no width
Stitch Length: 3-4
Presser Foot: General Purpose Foot
Needle Position: Center

Materials:

(2) 4" x 4" pieces of cotton, right sides together

Procedure:

- ◆ Place fabrics under the foot, matching the raw edges with the $\frac{5}{8}$ " seam guide.
- ◆ Sew the length of the fabric.
- ◆ Use the Reverse Button to reinforce the seam.

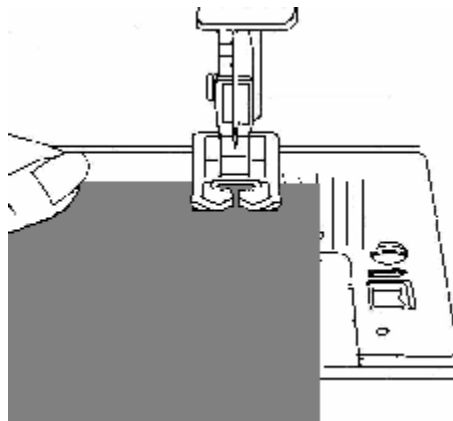
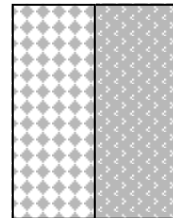

Straight Stitch for Topstitching

The Straight Stitch can be sewn “on top” of the fabric so that the stitches are visible. This is different from using the straight stitch to join a seam hidden inside the project. A topstitch provides a decorative touch while holding the seam allowances flat. It is also sturdy and durable.

Machine Set-Up:

Stitch: Straight Stitch
Pattern Selector: A
Stitch Width: 1, no width
Stitch Length: 3-4
Presser Foot: General Purpose Foot
Needle Position: Center



Materials:

(1) 5" x 5" piece of cotton

Procedure:

- ◆ Press a 1" hem on one side of the edge.
- ◆ Align the folded edge to the edge of the foot.
- ◆ Sew.
- ◆ Use the Reverse Button to reinforce the seam.

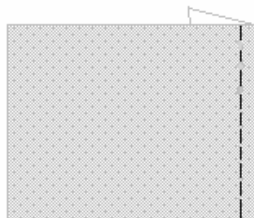

Create Quilted Fabric

Create your own quilted fabric with the Straight Stitch. Texture can be added to plain fabric by just adding consecutive rows of straight stitches!

Machine Set-Up:

Stitch: Straight Stitch
Pattern Selector: A
Stitch Width: 1, no width
Stitch Length: 3-4
Presser Foot: General Purpose Foot
Needle Position: Center

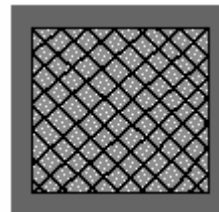

Materials:

(2) 5" x 5" pieces of cotton with batting between the two fabrics, creating a quilt-type sample

Procedure:

- ◆ Sew diagonally from the top left corner to the bottom right corner.
- ◆ Use the Reverse Lever to reinforce the seam.
- ◆ Position the foot's edge so that it rides on the previous row of stitching.
- ◆ Sew successive rows using the edge of the foot to ensure even spacing and straight lines.
- ◆ Change the direction, sew diagonally from the top right corner to the bottom left corner.

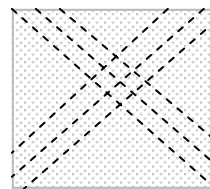
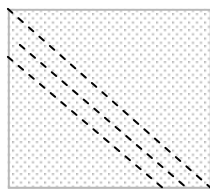
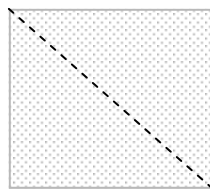

Speed Basting

Basting is used to temporarily hold fabrics together. Stitch length and tension are adjusted to create a looser stitch. This stitch can easily be removed with a seam ripper or simply pulled out.

Machine Set-Up:

Stitch: Straight Stitch
Pattern Selector: A
Stitch Width: 1, no width
Stitch Length: 5
Presser Foot: General Purpose Foot
Tension: Adjust the tension setting to a smaller number
Needle Position: Center

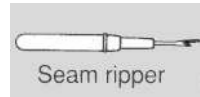

Materials:

(2) 4" x 4" pieces of cotton, right sides together

Procedure:

- ◆ Place under the foot, matching the raw edges with the $\frac{5}{8}$ " seam guide.
- ◆ Sew the length of the fabric.
- ◆ Use the seam ripper to remove a portion of the basting, or simply pull the bobbin thread to completely remove basting.

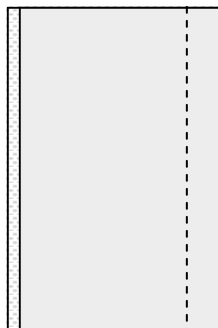

Making Piping

Piping adds a beautiful finish to projects such as pillows, sleeve edges, collars and more. The design of the Zipper Foot allows for the needle to stitch very closely to the edge of the foot. This is important when inserting zippers, applying piping or when topstitching close to the fabric's edge. Only the Straight Stitch can be used when sewing with the Zipper Foot.

Machine Set-Up:

Stitch: Straight Stitch
Pattern Selector: A
Stitch Width: 1, no width
Stitch Length: 3-4
Presser Foot: Zipper Foot
Needle Position: Center

Materials:

5" x 6" home décor fabric
7" piping cord

Procedure:

- ◆ Fold fabric, wrong sides together.
- ◆ Place piping inside of the fold.
- ◆ On the right side of the fabric, sew a straight stitch close to the piping.

Note: The Zipper Foot can be attached right or left, allowing for the piping to be inserted from either side.

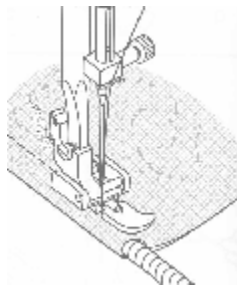

Attaching Purchased Piping

Attach pre-packaged piping to make a bold finish on home decorating projects, crafts or garments.

Machine Set-up:

Stitch: Straight Stitch
Pattern Selector: A
Stitch Width: 1, no width
Stitch Length: 3-4
Presser Foot: Zipper Foot
Needle Position: Center



Materials:

(2) 3" x 6" pieces of home décor fabric
7" pre-packaged piping

Procedure:

- ◆ Place fabric right sides together.
- ◆ Place piping between the fabrics, matching the piping's raw edge with the fabric's raw edges.

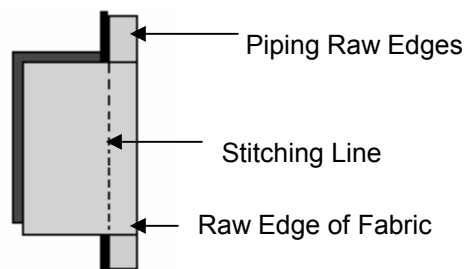

- ◆ On the wrong side of the fabric, sew a straight stitch close to the piping.

Note: The Zipper Foot can be attached right or left, allowing for the piping to be inserted from either side.

Centered Zippers

There are several ways of inserting zippers. The pattern envelope of the project or garment will designate the best type of zipper application, as well as the length and type of zipper to use. Most applications require a zipper foot.

Machine Set-Up:

Stitch: Straight Stitch
Pattern Selector: A
Stitch Width: 1, no width
Stitch Length: For basting: 5
For stitching: 3-4
Presser Foot: Zipper Foot
Tension: For basting: loosen the tension
For stitching: 3
Needle Position: Start with needle in left position

The needle can be moved to the left or right. This will allow stitching closer to the zipper than when the needle is in the center position.

Materials:

(1) 7" zipper
(2) 8" x 4" pieces of medium weight fabric
Transparent tape
Fabric glue stick

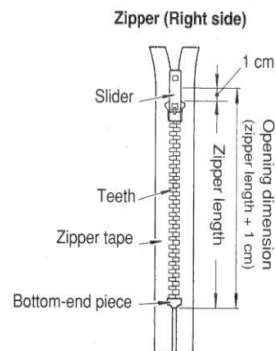

Procedure:

- ◆ Place fabric under the foot, matching the raw edges with the $\frac{5}{8}$ " seam guide.
- ◆ Starting at the top of the fabric, baste 7". Then change the stitch length to 3 and finish seaming the remaining length of the fabric.

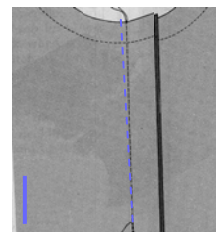

- ◆ Press the seam open. Finish raw edges if necessary.
- ◆ Apply glue stick lightly on the right side of the zipper.
- ◆ Place the zipper face-down, so that the zipper's coils or teeth are directly over the machine-basted seam. Pin in place, if necessary.

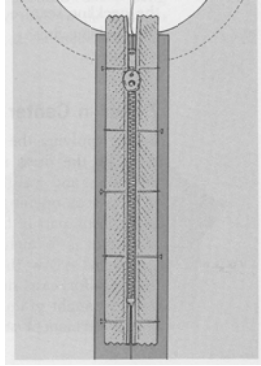

- ◆ Spread fabric flat, right side up and place ½" wide transparent or perforated marking tape on top of the centered seam line. The tape should be the length of the zipper (7" long for this exercise).
- ◆ Replace the Standard Presser Foot with the Zipper Foot. Adjust the foot to the left of the needle.
- ◆ On the right side of the fabric, stitch around the zipper. Pivot the fabric on the needle at the corners, using the edge of the tape as a guide.

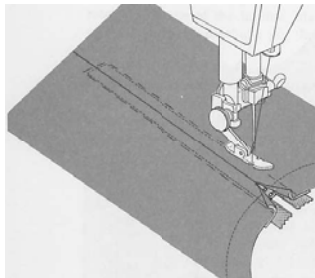

- ◆ Turn fabric to right side and remove the tape and the basting. Press.

Satin Stitch Appliqué

Satin Stitching is a series of closely spaced zig-zag stitches. Satin Stitching can be used for monograms, embroidery and appliqué work to produce a smooth satin-like appearance. Try a rayon thread for a smoother looking finish.

Machine Set-Up:

Stitch: Zigzag Stitch
Pattern Selector: A
Stitch Width: 2-3
Stitch Length: 0.5-1
Presser Foot: Special Purpose Foot (J)
Needle Position: Center



Materials:

2" x 3" cotton fabric for appliqué
2" x 3" fusible stabilizer
6" x 6" cotton foundation fabric
6" x 6" tear-away stabilizer

Procedure:

- ◆ Press the fusible stabilizer onto the appliqué.
- ◆ Fuse the appliqué onto the cotton foundation fabric.
(Fusing the appliqué into place will keep the appliqué from shifting while stitching.)
- ◆ Place a tear-away stabilizer underneath the fabric. (This is used to ensure quality stitching when using dense stitches.)
- ◆ Place the applique under the foot, so that half of the stitch will form on the applique and half on the base fabric.
- ◆ Sew around the applique.
- ◆ Widen the stitch width to 4 and change the stitch length to below 1.

- ◇ Sewing around the applique again, covering the previous stitching.

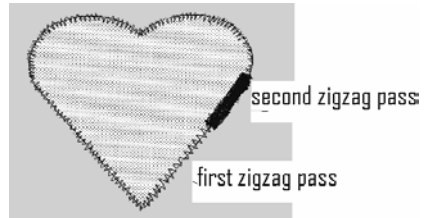

- ◇ Sewing over an applique twice is not always necessary, however, it does give a beautiful full-covered effect.

Lace Insertion

Insert lace into a special occasion garment or a home decorating project to create a beautiful heirloom keepsake.

Machine Set-Up:

| | |
|-------------------|--------------------------|
| Stitch: | Zigzag Stitch |
| Pattern Selector: | A |
| Stitch Width: | 2-3 |
| Stitch Length: | 1 |
| Presser Foot: | Special Purpose Foot (J) |
| Needle Position: | Center |



Materials:

5" x 3" of batiste
6" strip of lace
60-80 weight fine cotton thread

Procedure:

- ◆ Spray starch and iron the lace and batiste.
- ◆ Center the lace right side up, lengthwise on batiste.
- ◆ Stitch lace to fabric by sewing a zigzag stitch down both edges of the lace. Try to just clear the heading of the lace.

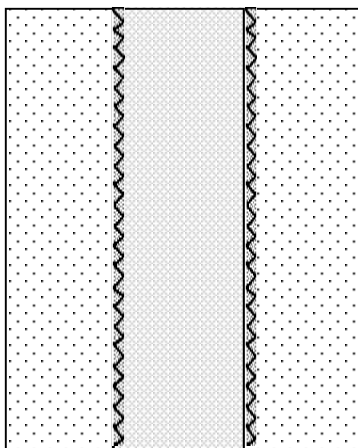

- ◇ Carefully cut under the lace down the center.

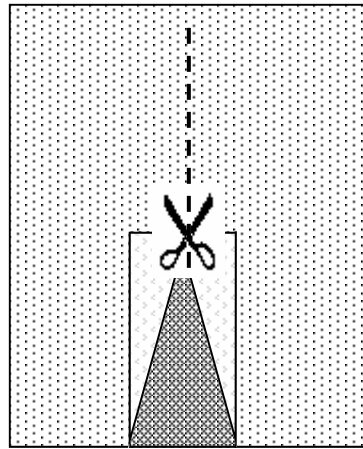

Back side of fabric

Lace

- ◇ Turn these raw edges back away from the lace, then finger press.
- ◇ Finish fabric's edges by sewing a small zigzag through all layers, being careful not to catch too much lace.
- ◇ Turn fabric over and trim excess fabric seam allowances away.

Note: A nice touch can be added by stitching a row of decorative stitches down each side of the lace.

Button Sewing

Use your sewing machine to sew on buttons, snaps or hooks with ease. This is especially helpful when making a large project where several buttons need to be attached, such as a shower curtain that has button tabs.

Machine Set-Up:

Stitch: Zigzag Stitch
Pattern Selector: A
Stitch Width: Determined by button
(width between the holes is usually 3mm)
Stitch Length: N/A
Feed Dogs: Lowered Feed Dogs
Presser Foot: Button Sewing Foot*
Needle Position: Center

Materials:

Home décor fabric or shirting
One 2-hole button
Liquid fray preventer



Procedure:

- ◆ Lower the Feed Dogs
- ◆ Fold fabric in half and place under presser foot.
- ◆ Position the button on the fabric so that the holes in the button are between the toes of the foot.

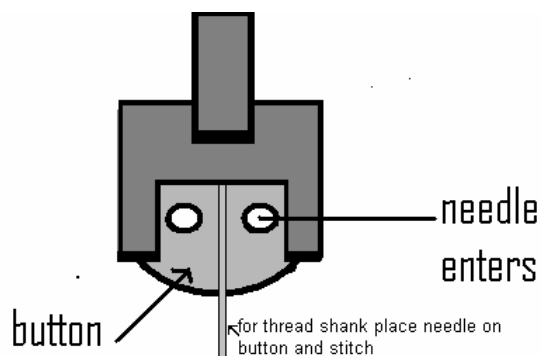

*The Button Sewing Foot is optional. Check with your SINGER® Retailer.

- ◆ Lower the presser foot to hold the button in place.
- ◆ Turn the hand wheel forward, adjust so that the needle goes into the right or left hole.
- ◆ Adjust the stitch width dial to fine tune the swing of the needle into the opposite hole.
- ◆ Recheck the swing of the needle into the opposite hole and then use the foot control to sew 5-6 stitches.
- ◆ Before removing the button and fabric from the machine, set machine to straight stitch. Leave width at current setting and stitch in place for three stitches. This forms a tie-off on the back side to secure the button.
- ◆ Apply a liquid fray preventer on the backside of fabric on the knots. Trim threads after they dry, being careful not to cut thread knots.

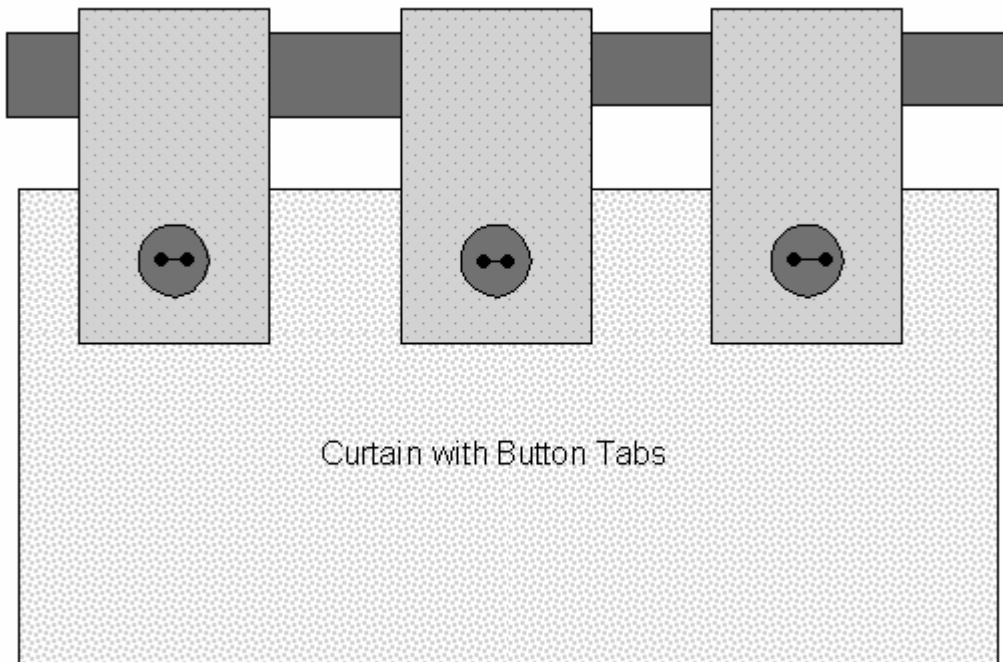

Four-Step Buttonholes

The built-in buttonhole is divided into four different steps. This simple process provides reliable results for buttonholes on garments, home decorating projects and crafts.

Machine Set-Up:

| | |
|-------------------|-----------------------------------|
| Stitch: | Step One of the 4-step buttonhole |
| Pattern Selector: | A |
| Stitch Width: | Changes automatically |
| Stitch Length: | Step #1 of Buttonhole Dial |
| Presser Foot: | Buttonhole Foot |
| Needle Position: | Changes automatically |

(See manual for complete machine set-up for buttonholes.)

Materials:

Home décor fabric with interfacing or tear-away stabilizer
Disappearing fabric marking pen or tailor chalk (for marking size of buttonhole)
Button (to establish length of buttonhole)
Liquid fray preventer

Procedure:

- ◆ Fold fabric in half crosswise, with interfacing or stabilizer placed between layers.

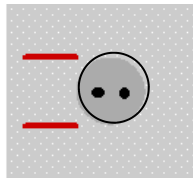

- ◆ Lay button on fabric and mark the top and bottom of the button. This will establish the starting and ending point of the buttonhole.

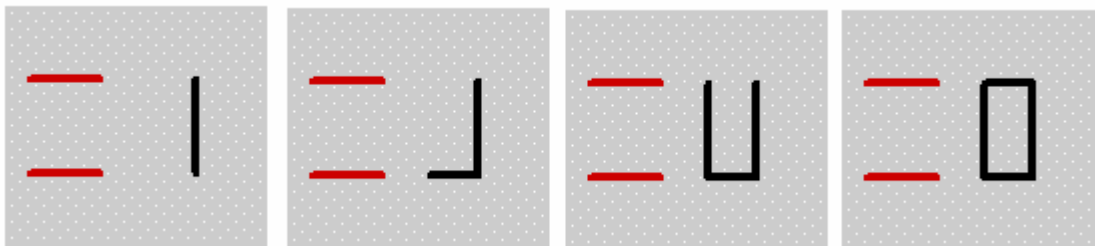

- ◆ Place the fabric under the foot, matching the foot's red mark with the top mark on the fabric.

- ◆ Turn Pattern Selection knob to Step One of the Four-Step buttonhole.
- ◆ Sew, and the machine will stitch the right side of the buttonhole.
- ◆ Stop sewing when the needle reaches the fabric mark which indicates the bottom of the buttonhole.
- ◆ Turn Pattern Selection knob to Step Two of the Four-Step buttonhole.
- ◆ Sew 5 to 6 stitches, bartacking the bottom of the buttonhole.
- ◆ Turn Pattern Selection knob to Step Three of the Four-Step buttonhole.
- ◆ Sew, and the machine will stitch in reverse, making the left side of the buttonhole.
- ◆ Stop sewing when the needle reaches the fabric mark which indicates the top of the buttonhole.
- ◆ Turn Pattern Selection knob to Step Four of the Four-Step buttonhole.
- ◆ Sew 5 to 6 stitches, bartacking the top of the buttonhole.
- ◆ Cut open buttonhole and use a liquid fray preventer to reinforce the buttonhole.

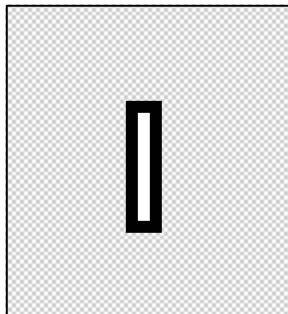

Free-Motion Monogramming

Monogramming adds a personal and professional touch to garments, home decorating items and craft projects. When monogramming, the feed dogs are covered, allowing for free-motion sewing.

Machine Set-Up:

Stitch: Zigzag Stitch
Pattern Selector: A
Stitch Width: 2
Stitch Length: N/A
Feet Dogs: Lowered
Presser Foot: Embroidery/Darning Foot*
(or remove the foot completely)
Needle Position: Center



Materials:

Embroidery hoop
8" x 8" cotton with an iron-on interfacing
Fabric marking pen

Procedure:

- ◆ Using the fabric marking pen, draw the desired monogram letter.
- ◆ Place fabric in the embroidery hoop, making sure the fabric is taut.
- ◆ Place the hoop under the foot, positioning the needle over the starting point of the monogram.
- ◆ Lower the presser foot.

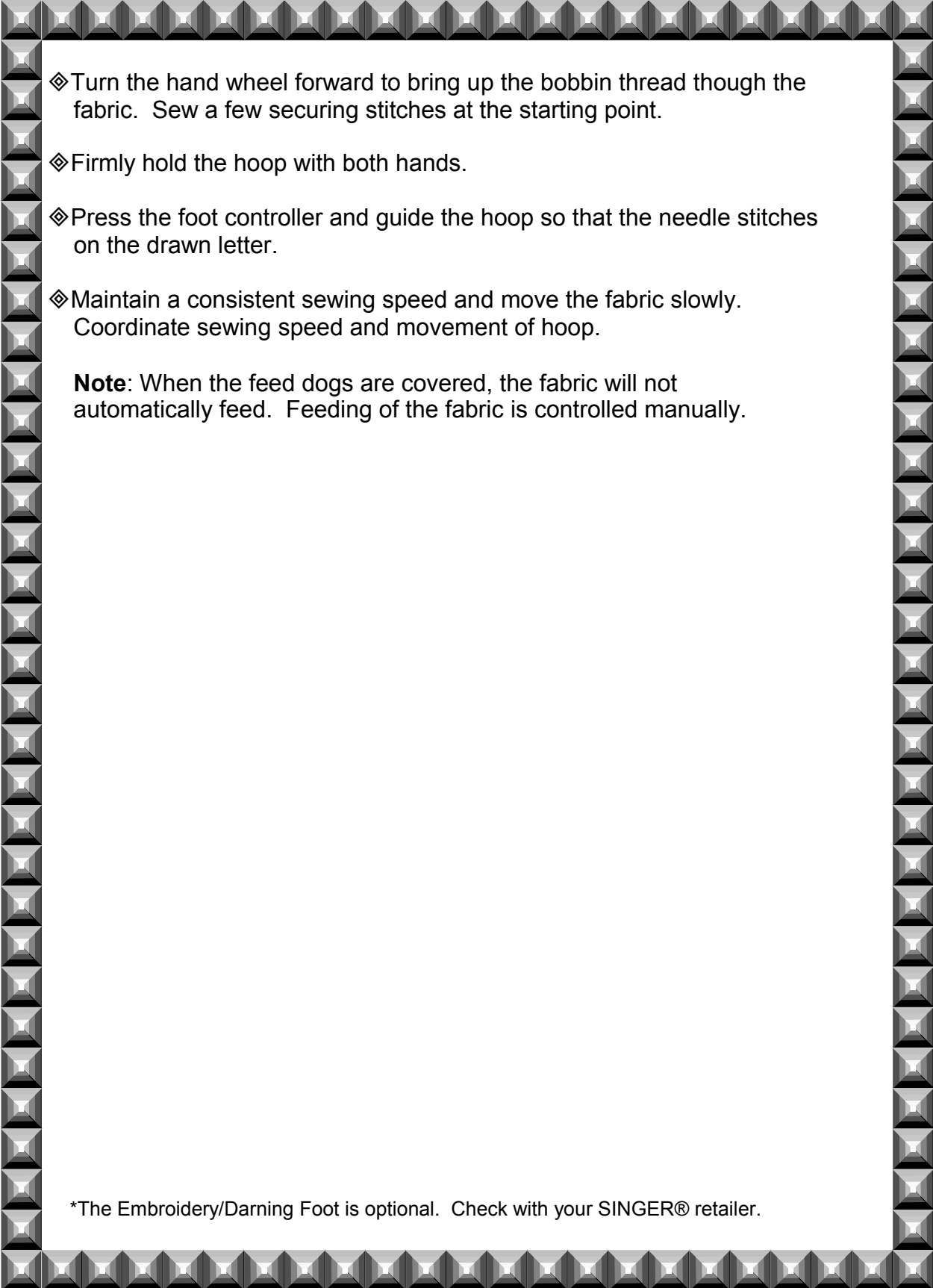

- 
- ◆ Turn the hand wheel forward to bring up the bobbin thread through the fabric. Sew a few securing stitches at the starting point.
 - ◆ Firmly hold the hoop with both hands.
 - ◆ Press the foot controller and guide the hoop so that the needle stitches on the drawn letter.
 - ◆ Maintain a consistent sewing speed and move the fabric slowly. Coordinate sewing speed and movement of hoop.

Note: When the feed dogs are covered, the fabric will not automatically feed. Feeding of the fabric is controlled manually.

*The Embroidery/Darning Foot is optional. Check with your SINGER® retailer.

Free-Motion Embroidery

Free-motion embroidery is an elegant embellishment. The embroidery can be extremely detailed, such as the embroidery on a bridal gown. It also can be as simple as a row of flowers on kitchen linens.

Machine Set-Up:

Stitch: Zigzag Stitch
Pattern Selector: A
Stitch Width: 2 or smaller
Stitch Length: N/A
Foot Dogs: Lowered
Presser Foot: Embroidery/Darning Foot*
or remove the foot completely
Needle Position: Center



Materials:

Embroidery hoop
8" x 8" cotton with an iron-on interfacing
Fabric marking pen

Procedure:

- ◆ Using the fabric marking pen, draw the desired design or trace a simple design.
- ◆ Place fabric in the embroidery hoop, making sure the fabric is taut.
- ◆ Place the hoop under the foot, positioning the needle over the starting point of the design.
- ◆ Lower the presser foot.
- ◆ Turn the hand wheel forward to bring up the bobbin thread through the fabric. Sew a few securing stitches at the starting point.



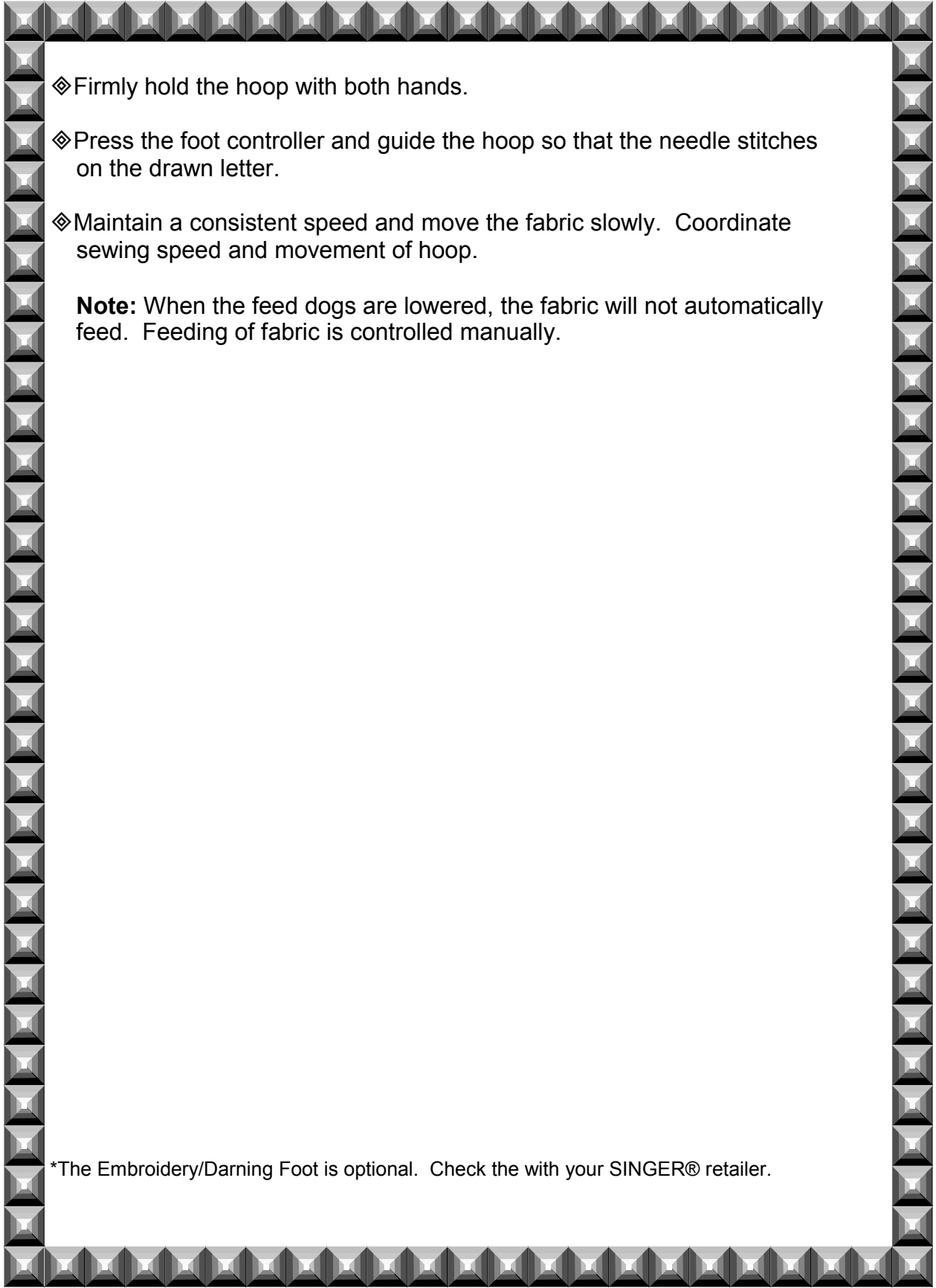

◆ Firmly hold the hoop with both hands.

◆ Press the foot controller and guide the hoop so that the needle stitches on the drawn letter.

◆ Maintain a consistent speed and move the fabric slowly. Coordinate sewing speed and movement of hoop.

Note: When the feed dogs are lowered, the fabric will not automatically feed. Feeding of fabric is controlled manually.

*The Embroidery/Darning Foot is optional. Check the with your SINGER® retailer.

Blindstitch Hem

A Blindstitch Hem is a fast way to finish hems securely on skirts or pants. It also makes a great choice when hemming large projects such as curtains or bed skirts. Use matching thread to help the stitches blend into the fabric, hence becoming “blind” or invisible.

Machine Set-Up:

Set-up for Step 1 (to finish raw edges)

| | |
|-------------------|----------------------|
| Stitch: | Zigzag Stitch |
| Pattern Selector: | A |
| Stitch Length: | 1.0 |
| Stitch Width: | 3 |
| Presser Foot: | Blindstitch Hem Foot |
| Needle Position: | Center |

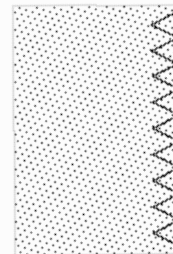

Set-up for Step 2 (to baste the fold)

| | |
|-------------------|-----------------|
| Stitch: | Straight Stitch |
| Pattern Selector: | A |
| Stitch Length: | 4 |
| Stitch Width: | 0 |
| Tension Dial: | 2 |
| Presser Foot: | Standard Foot |
| Needle Position: | Center |

Set-up for Step 3 (to create the hem)

| | |
|-------------------|----------------------|
| Stitch: | Blindstitch |
| Pattern Selector: | B |
| Stitch Length: | 2-3 |
| Stitch Width: | 3-4 |
| Tension Dial: | 2 |
| Presser Foot: | Blindstitch Hem Foot |
| Needle Position: | Center |

Materials:

Medium weight woven fabric

Procedure:

◆ Sew a Zigzag to finish one of the fabric's raw edges.

- ◆ Fold under 1" and baste in place.

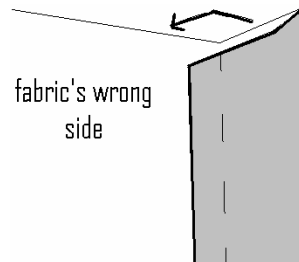

- ◆ Position fabric with wrong side facing up, and turn the hem back to the right side, creating a soft fold at the top edge of the hem. The bulk of the fabric is to the left of the foot.

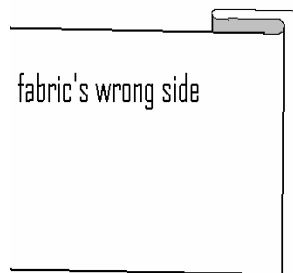

- ◆ Begin stitching, making sure the forward stitches fall near the ¼" fold, and the needle swing just bites into the fold, catching only 2 or 3 threads.

Note: Always use matching thread to help “hide” the stitches.

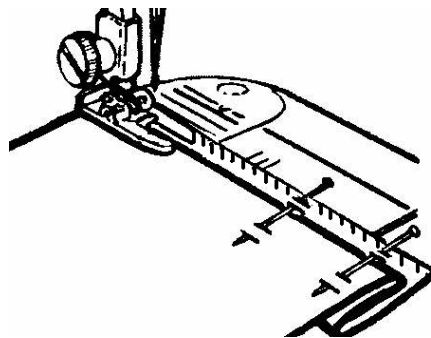

Attaching Beaded Trims

Adding a trim is an easy way to enhance almost any project! The look of a denim jacket can be changed with a row of trim around the bottom edge. A pair of capri pants can be dressed up by sewing a beaded trim around each pant hem. Home decorating projects such as pillows, bedspreads or table runners can have a “face-lift” by just adding a beaded trim.

Machine Set-Up:

Stitch: Multi-Stitch Zigzag
Pattern Selector: C
Stitch Width: 4-5
Stitch Length: 3
Presser Foot: Special Purpose Foot (J)
Needle Position: Center



Materials:

Beaded trim
Home décor fabric

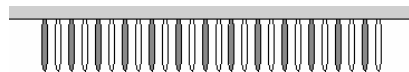

Procedure:

- ◆ Press and sew a 1” hem in the fabric, using a straight stitch.
- ◆ Place fabric on machine with wrong side facing up.
- ◆ Place trim header on fabric’s edge, right side facing down.
- ◆ Sew on the the trim’s header.

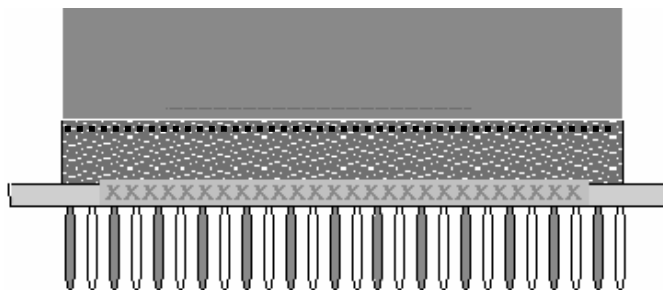

Mending with Multi-Stitch Zigzag

The Multi-Stitch is a three-step zigzag stitch. It is stronger than a traditional zigzag stitch and is used for mending, reinforcing a seam, darning, applying elastic and many other techniques. It is ideal when mending tears.

Machine Set-Up:

| | |
|-------------------|--------------------------|
| Stitch: | Multi-Stitch Zigzag |
| Pattern Selector: | C |
| Stitch Width: | 2-5 |
| Stitch Length: | 0.5-1 |
| Presser Foot: | Special Purpose Foot (J) |
| Needle Position: | Center |



Materials:

2" x 2" denim square
5" x 5" denim, cut a 1" tear in center of denim

Procedure:

- ◆ Use the small denim square as a backing to add reinforcement.
- ◆ Stitch directly over the tear. Turn handwheel to lower needle into the fabric. Pivot 180 degrees and sew again.

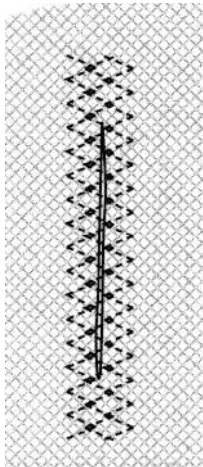

Crazy Quilting

Crazy Quilting is done by stitching scraps of velvets, silks, cottons, satins and other fine fabrics onto a foundation fabric. The fabrics are various shapes. The fabric edges are then embellished with decorative stitches, often done with decorative threads. This technique is popular and can be used in wearable art, home decorator projects and more.

Machine Set-Up:

Stitch: Decorative Stitches
Pattern Selector: B, C, D, E, F, G or H
Stitch Width: Adjust according to preference
Stitch Length: Adjust according to preference
Presser Foot: Special Purpose Foot (J)
Needle Position: Center

Materials:

Fabric scraps
Foundation fabric or paper
Various decorative threads

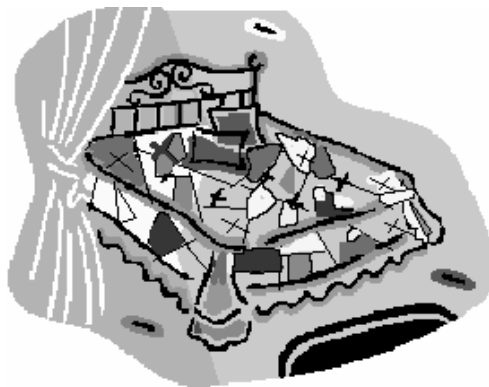

Procedure:

- ◆ Crazy-piece the scraps onto the foundation fabric or paper, starting from the center and working outward.
- ◆ Select desired decorative stitch and center the stitching over the seam lines.
- ◆ Use rayon, metallic or other decorative threads, as desired.

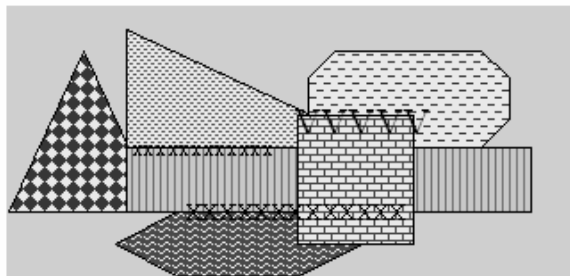

Straight Stretch Stitch for Woven Fabrics

This stitch is wonderful for built-in strength! It is ideal when sewing heavy-weight fabrics or when it is desired to have a bolder-looking straight stitch. Try it as a topstitch on jeans, a home decorating project, or when an extra-strong seam is needed, such as in children's clothing.

Machine Set-Up:

Stitch: Straight Stretch Stitch
Pattern Selector: A
Stitch Width: 1, no width
Stitch Length: Stretch Setting
Presser Foot: Special Purpose Foot
Needle Position: Center

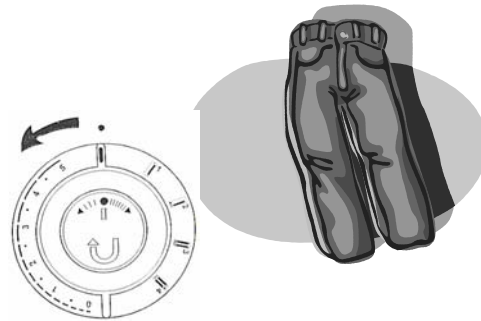

Stretch Setting

Materials:

Denim, folded in half

Procedure:

◆ Stitch the two layers.

Note: Slowly turn the handwheel and watch the needle repeat each stitch 3 times. By repeating the stitch, the stitch is much stronger.

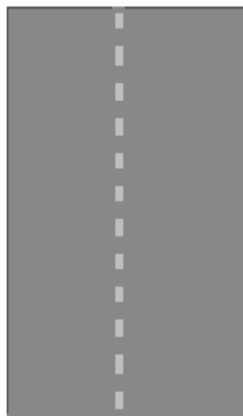

Straight Stretch Stitch for Stretch Fabrics

In the 1970's, fabrics that had stretch were introduced. Previously, only woven-type fabrics were available for home sewers. When a standard straight stitch is sewn on stretch fabric, it will "pop" or break when the fabric is stretched. Special stitches were created to allow "no-pop" sewing on stretch fabrics, and these stitches are called Stretch Stitches or Flexi-stitches. Today, stretch fabrics are used to make exercise outfits, dance costumes, swimsuits and much more. As the fabrics of these garments stretch, so do the stitches!

Machine Set-Up:

Stitch: Straight Stretch Stitch
Pattern Selector: A
Stitch Width: 1, no width
Stitch Length: Stretch Setting
Presser Foot: Special Purpose Foot
Needle Position: Center



Materials:

Knit fabric, folded in half



Stretch Setting

Procedure:

◆ Stitch the two layers.

Note: After sewing, notice how the stitch stretches with the fabric.



Ribbing Application

The Overedge Stretch Stitch makes sewing seams on knits look as though they were finished on a serger. This stitch is stronger and more durable than overlock/serger stitching. The stitch incorporates a straight stitch and a finishing stitch into one operation. This allows for professional finish on projects, and is especially popular on sweatshirts.

Machine Set-Up:

Stitch: Overedge Seam Stitch
Pattern Selector: D
Stitch Width: 5
Stitch Length: Stretch Setting
Presser Foot: Special Purpose Foot (J)*
Needle Position: Center



Stretch Setting

Materials:

6" x 6" Medium to heavy weight knit fabric or polar fleece
3" x 6" Ribbing

Procedure:

- ◆ Cut a curve in the knit fabric to resemble a neckline.
- ◆ Fold ribbing in half lengthwise.
- ◆ Starting at the left side of the knit curve, place ribbing on front side of curve.
- ◆ Match all 3 cut edges and place under the presser foot.
- ◆ Line up fabric edges with guide on foot and stitch the length of the seam.

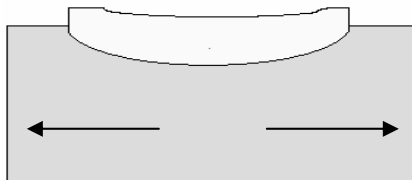

- ◆ Stretch ribbing slightly to fit the cut edges of the knit.
- ◆ When finished, lift foot and pull threads and fabric straight back behind foot and trim.

*The Overedge Foot is optional. Check with your SINGER® Retailer.

Overedge Stitching

When joining two pieces of fabric, it is usually necessary to finish the edges. This prevents raveling of the fabric and provides for a professional finish.

Machine Set-Up:

Stitch: Overedged Seam Stitch
Pattern Selector: D
Stitch Width: 5
Stitch Length: Stretch Setting
Presser Foot: Special Purpose Foot (J)
Needle Position: Center

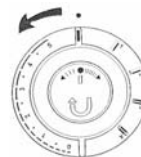

Stretch Setting

Materials:

(2) pieces of woven fabric

Procedure:

- ◆ Right sides together, place the fabric under the foot.
- ◆ Align the fabric's edges with the foot's edge.
- ◆ Sew, joining two pieces of fabric and finishing the edges in one operation.

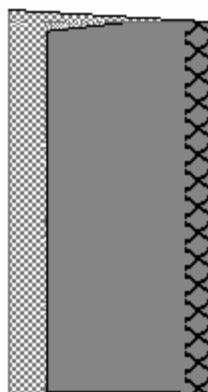

*The Overedge Foot is optional. Check with your SINGER® Retailer.

Seam Allowances with Stretch Overedged Seam Stitch

This technique is ideal for making an unlined garment or when the seam allowances may show. All the edges are finished prior to construction. This prevents raveling of the fabric and makes a professional finish on woven and knit fabrics.

Machine Set-Up:

Stitch: Overedged Seam Stitch
Pattern Selector: D
Stitch Width: 5
Stitch Length: Stretch Setting
Presser Foot: Special Purpose Foot (J)*
Needle Position: Center



Stretch Setting

Materials:

(2) 4" x 3" pieces of heavy woven fabric

Procedure:

- ◆ Place one piece of fabric under the foot, aligning the fabric edge so that the stitch forms just on the edge of the fabric.
- ◆ Place the second piece of fabric under the foot, aligning the fabric edge so that the stitch forms just on the edge of the fabric. Sew.
- ◆ Change to the Standard Foot and set machine for a straight stitch.
- ◆ With right sides together, join the two pieces of fabric with a $\frac{5}{8}$ " seam allowance.
- ◆ Open seam flat and press.

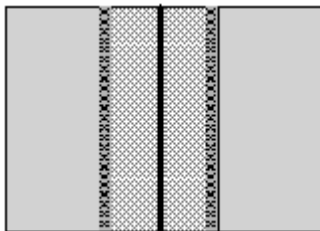

*The Overedge Foot is optional. Check with your SINGER® Retailer.

Attaching Elastic

Elastic can be applied directly to the fabric, such as when making lingerie. If the elastic is $\frac{3}{8}$ " wide or less, the elastic can be placed into the General Purpose Foot's opening, making it easier to evenly stretch the elastic while sewing.

Machine Set-Up:

Stitch: Honeycomb Stitch
Pattern Selector: C
Stitch Width: 5
Stitch Length: 2-3
Presser Foot: General Purpose Foot
Needle Position: Center



Stretch Setting

Materials:

Nylon Tricot 4" x 8"
 $\frac{3}{8}$ " wide elastic strip, cut 7" long

Procedure:

- ◆ Thread elastic through the needle-opening hole in the foot.
- ◆ Pull 2-3" of elastic to the back of the foot, enough to firmly grasp.
- ◆ Position fabric under the foot.
- ◆ Sew, gently pulling the elastic while sewing.



Sewing with a Wing Needle

Use a Wing Needle to create a beautiful heirloom look on pillowcases, napkins, or special occasion garments. A Wing Needle is very wide and makes a large opening or hole in the fabric every time it stitches. Several different types of stitches can be used. For best results, use a stitch with forward-back movement, so that the needle penetrates the same hole more than once.

Machine Set-Up:

Stitch: Zigzag Stitch
Pattern Selector: A
Stitch Width: 1-2
Stitch Length: 3-5
Presser Foot: Special Purpose Foot (J)
Needle: Wing Needle*
Needle Position: Center

Materials:

Linen or other natural fiber fabric, spray-starched for added firmness
60-80 weight sewing thread
60-80 weight sewing thread in bobbin

Procedure:

- ◆ Pull one or two threads to establish a guideline for stitching.
- ◆ Stitch along the pulled threads. Notice the pronounced holes that are created by the stitching.

Note: An alternative method is to trace a design onto fabric using chalk, water-soluble or air soluble marker. (Use stencils, templates or create a design.) Stitch along the drawn lines of the design.

* Wing Needle is an optional accessory. Check with your SINGER® Retailer.

Twin Needle Sewing

By using a Twin Needle, two parallel rows of stitching can be sewn at the same time. A straight stitch using a twin needle sewing creates a sporty hem on knit wear, a sophisticated top-stitch or a decorative embellishment.

Machine Set-Up:

| | |
|-------------------|--|
| Stitch: | Straight Stitch |
| Pattern Selector: | A |
| Stitch Width: | 1, no width |
| Stitch Length: | 3-5 |
| Presser Foot: | Special Purpose Foot or General Purpose Foot |
| Needle: | Twin Needle* |
| Needle Position: | Center |

Materials:

5" x 5" piece of medium weight fabric, with a stabilizer ironed on

Procedure:

- ◆ Insert the second spool pin.
- ◆ Both spools of thread follow the same threading path until they reach the eye of the needle. Thread each needle separately.
- ◆ Slowly sew a row of stitching on the right side of the fabric.
- ◆ Maintain a slow consistent speed to ensure accurate stitching.

Note: When sewing with a stitch that has width (such as a zigzag or decorative stitch) and the twin needle, always test that the needle does not hit the foot, by turning the hand wheel manually.

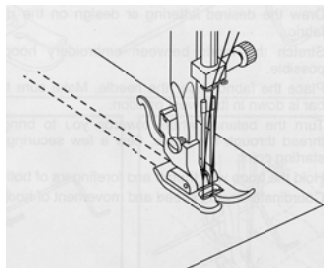

*Twin needle is an optional accessory. Check with your SINGER® Retailer.

Applying Ribbon with a Twin Needle

By using a Twin Needle, two parallel rows of stitches can be used to attach a ribbon while stitching.

Machine Set-Up:

Stitch: Straight Stitch
Pattern Selector: A
Stitch Width: 1, no width
Stitch Length: 5
Presser Foot: Transparent Satin Foot or Standard Foot
Needle: Twin Needle
Needle Position: Center

Materials:

5" x 5" piece of lightweight woven fabric, with a stabilizer ironed on
6" long piece of ¼" wide satin ribbon

Procedure:

- ◆ Insert the second spool pin.
- ◆ Both spools of thread follow the same threading path until they reach the eye of the needle. Thread each needle separately.
- ◆ Insert the ribbon through the openings in the presser foot. Pull the ribbon under the foot and then to the back of the foot.
- ◆ Slowly sew a row of stitching on the right side of the fabric.
- ◆ Maintain a slow consistent speed to ensure accurate stitching.

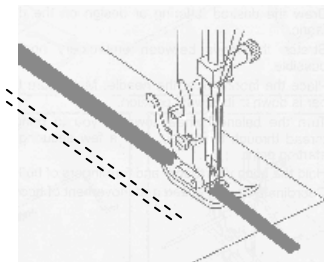

*Twin Needle is an optional accessory. Check with your SINGER® Retailer.

Sewing on Leather

Leather can add a bold accent to a garment, home decorating or craft project. Leather does not ravel, so there is no need to finish the seam edges.

Machine Set-Up:

Stitch: Straight Stitch
Pattern Selector: A
Stitch Width: 1, no width
Stitch Length: 3
Presser Foot: Special Purpose Foot (J)
or General Purpose Foot
Needle: Leather Needle*
SINGER PN#260-203286089S198, Wedge Point Needle
Needle Position: Center



Materials:

Fashion leather

Procedure:

- ◆ Finger press a 1" hem in the leather.
- ◆ Sew, using the seam guides to ensure straight stitching.

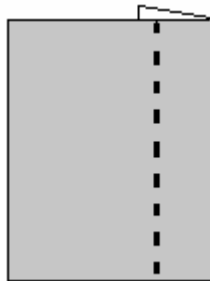

NOTE:

The optional Roller Foot or Even Feed Foot feeds the leather, vinyl or suede through the machine more easily.

* The Leather needle is optional. Check with you SINGER® Retailer.

Decorative Stitching

Your sewing projects can have diversity, originality and creativity by adding one or more of the available decorative stitches. By embellishing a project with decorative stitches you can create an original work of art.

Machine Set-Up:

Stitch: Domino Stitch
Pattern Selector: F
Stitch Width: 5
Stitch Length: 1
Presser Foot: Special Purpose Foot (J)
Needle Position: Center



Stretch Setting

Materials:

(1) 4" x 4" piece of cotton
(1) 4" x 4" piece of stabilizer

Procedure:

- ◆ Place stabilizer behind the cotton piece.
- ◆ Sew across the fabric.
- ◆ Use the Reverse Button to reinforce the seam.



Joining Fabric with the Herringbone Stitch

Your sewing projects can have diversity, originality and creativity by adding one or more of the available decorative stitches. By embellishing a project with decorative stitches you can create an original work of art. The Herringbone Stitch is often used to join pieces of fabric and decorative top-stitching.

Machine Set-Up:

Stitch: Herringbone Stitch
Pattern Selector: H
Stitch Width: 5
Stitch Length: Stretch Setting
Presser Foot: Special Purpose Foot (J)
Needle Position: Center



Stretch Setting

Materials:

(1) 4" x 4" pieces of lawn
(1) 5" long piece of 1" wide lace

Procedure:

- ◆ Spray starch and iron the lace and batiste.
- ◆ Center the lace right side up, lengthwise on the lawn.
- ◆ Stitch lace to fabric by sewing the decorative stitch down both edges of the lace.

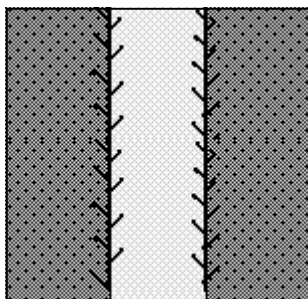

Decorative Stippling

The Double Action Stitch simulates free-motion stippling. It is a creative way to decorate craft projects, home decorating projects or wearable art. Try stitching fabric prior to appliqué to create texture to the appliqué fabric.

Machine Set-Up:

Stitch: Double Action Stitch
Pattern Selector: G
Stitch Width: 5
Stitch Length: Stretch Setting
Presser Foot: Special Purpose Foot (J)
Needle Position: Center

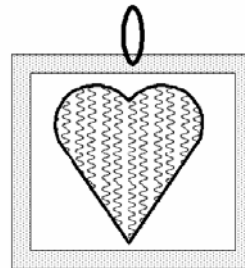

Materials:

(2) 4" x 4" pieces of cotton
(1) 4" x 4" piece of batting



Stretch Setting

Procedure:

- ◆ Place the batting between the cotton pieces.
- ◆ Sew several rows of the Double Action Stitch.

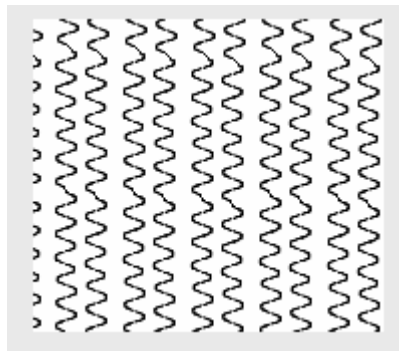

Scalloped Edge

The delicate scallop stitch creates a beautiful , graceful edging for dresses, blouses, lingerie and children's clothes. It also makes an distinctive decorative edge finish to home linens.

Machine Set-Up:

| | |
|-------------------|--------------------------|
| Stitch: | Scallop Stitch |
| Pattern Selector: | E |
| Stitch Width: | 5 |
| Stitch Length: | 1 or below |
| Presser Foot: | Special Purpose Foot (J) |
| Needle Position: | Center |

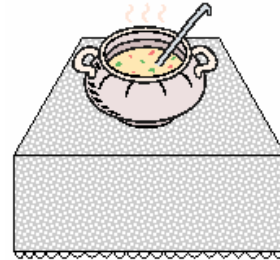

Materials:

- (1) 4" x 4" Light weight fabric, such as lawn
- (1) 3" x 5" Rinse-away stabilizer
- 30 weight decorative thread

Procedure:

- ◆ Fold fabric in half.
- ◆ Place stabilizer under fabric fold, extending 1" beyond fabric edge.
- ◆ Stitch a row of Scallop stitches. Align center of foot on the folded edge.
- ◆ Trim away excess stabilizer, then rinse with water to remove remaining stabilizer.

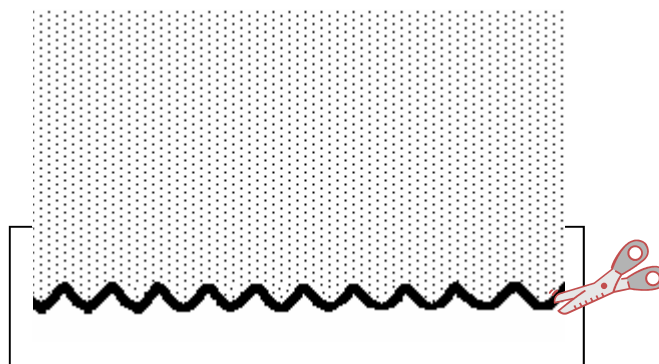

Narrow Hem

The edge of a ruffle, the hem on a napkin and the edge of a prom dress are all perfect examples of where it is beneficial to use the Rolled Hem Foot. The foot has a “scroll” that helps roll the fabric’s edge over, hiding the raw edges and creating a small professional finish hem. Soft fabrics roll best.

Machine Set-Up:

Stitch: Straight Stitch
Pattern Selector: A
Stitch Width: 1, no width
Stitch Length: 3
Presser Foot: Rolled or Narrow Hem Foot*
Needle Position: Center

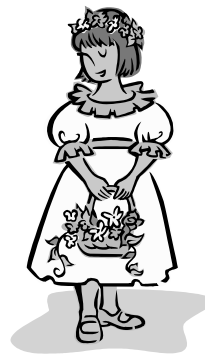

Materials:

Medium to light weight fabric

Procedure:

- ◆ Press a $\frac{1}{8}$ " hem to approximately 1 inch of the fabric's edge.
- ◆ Stitch the small hem into place with a straight stitch.
- ◆ Leave the needle in the fabric, but lift the presser foot.
- ◆ Guide the fabric into the scroll of the foot.
- ◆ Lower foot and continue to sew, holding the thread tails firmly.
- ◆ Hold fabric taut and slightly up to help the fabric to “roll” into the scroll.

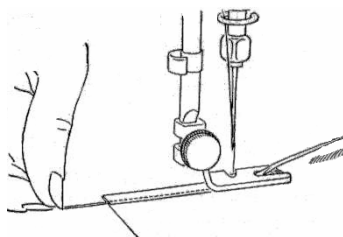

*The Rolled/Narrow Foot is optional. Check with your SINGER® Retailer.

Gathering with the Cording Foot

This technique is great for heavy fabrics such as in home decorating or textured fabrics that do not gather easily. The Cording Foot holds the cord in place, so stitching is effortless. Adjusting gathers is easy, and there is no danger that the cord will break in the middle of the project.

Machine Set-Up:

Stitch: Zigzag Stitch
Pattern Selector: A
Stitch Width: 3
Stitch Length: 3
Presser Foot: Cording Foot*
Needle Position: Center

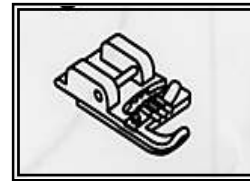

Materials:

10" long strand of fine cord
Home décor fabric

Procedure:

- ◆ Place a single cord in the center groove of the foot.
- ◆ Secure the cord by tying a knot at the back of the foot.
- ◆ Place the fabric under the foot.
- ◆ Sew a test to ensure that the Zigzag stitches are sewing over the cord, not into the cord. The Zigzag stitch is making a casing for the cord.
- ◆ After stitching is finished, pull the cord which will draw up or gather the fabric.
- ◆ Adjust the gathers evenly by sliding the fabric along the cord.
- ◆ Sew a straight stitch to secure the gathers into place.

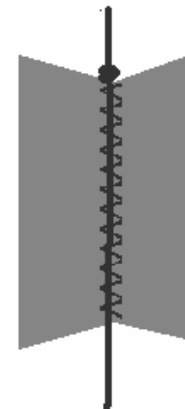

*The Cording Foot is optional. Check with your SINGER® Retailer.

Applying Trims, Cords or Braids

Use the Cording Foot to easily apply thin cords to add texture to wearable art fashions or home decorating projects. The foot holds the cords in position, so that it is effortless to stitch them into place. There are several decorative cords available, each creating a different effect. Experiment with various cords and stitches!

Machine Set-Up:

| | |
|-------------------|---------------|
| Stitch: | Multi-Zigzag |
| Pattern Selector: | C |
| Stitch Width: | 3 |
| Stitch Length: | 3 |
| Presser Foot: | Cording Foot* |
| Needle Position: | Center |

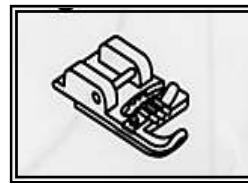

Materials:

Three strands of thin cording
Home Décor fabric

Procedure:

- ◆ Thread one decorative cord through each of the foot's three grooves or slots.
- ◆ Secure the three cords at the back of the foot by tying a knot.
- ◆ Place the fabric under the foot and sew.
- ◆ The foot will hold all the cords in place as they are sewn into the fabric.

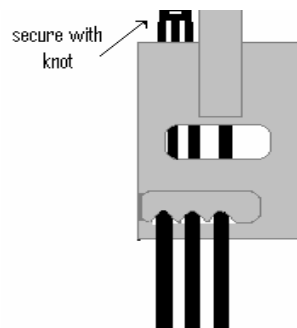

*The Cording Foot is optional. Check with your SINGER® Retailer.

Shirring with the Gathering Foot

Gathering fabric means to draw the fabric up on a thread to create fullness. Shirring consists of three or more rows of gathers. Use only sheer or soft fabrics for this technique. The specially designed Shirring Foot pushes fabric into even folds under the needle. The stitch then holds the fabric folds securely.

Machine Set-Up:

Stitch: Straight Stitch
Pattern Selector: A
Stitch Width: 1, no width
Stitch Length: 5
Fullness is regulated by stitch length
Tension: Increase the tension
Presser Foot: Gathering Foot*
Needle Position: Center



Materials:

Lightweight fabric, such as batiste

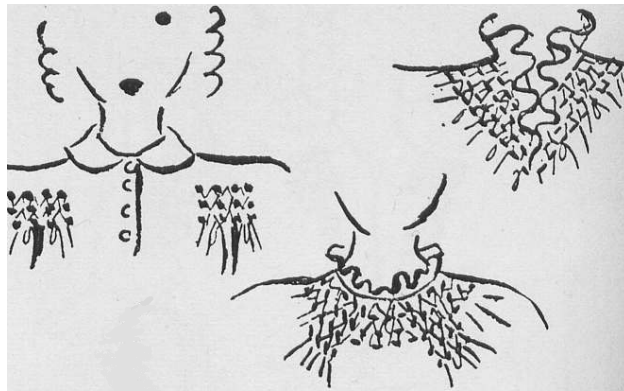

Procedure:

- ◆ Pull one to two threads on the fabric's crosswise grain, to create a guide for straight stitching.

*The Gathering Foot is optional. Check with your SINGER® Retailer.

- ◆ Turn the handwheel to ensure the needle is correctly positioned. It should line up with the Gathering Foot's needle opening.
- ◆ Sew a row on top of the "pulled" line.
- ◆ Use the foot's edge as a guide to sew the next row of stitching. Rows will be $\frac{1}{4}$ " apart if the foot is used as a guide.

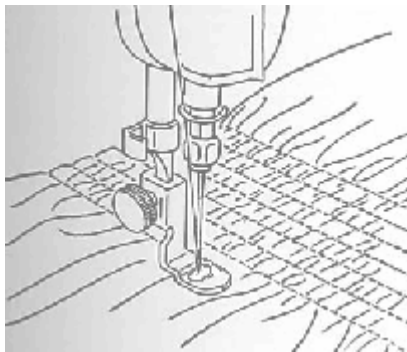

- ◆ Sew 3 or 4 more rows.
- ◆ Do not clip thread ends until it is determined if any fine adjustments are needed to make the gathers even-looking.



Using the Even Feed Foot to Sew Multiple Fabric Layers

The Even Feed Foot has its own set of feed dogs that work in conjunction with the machine's feeding system to improve the flow of the fabric. This is particularly important when sewing several layers of fabric, such as in quilting. The Even Feed Foot "pulls" the top layer or layers of fabric through at the same speed as the machine's feed dogs are pulling the bottom layer or layers of fabric, making for more even feeding!

Machine Set-Up:

Stitch: Straight Stitch
Pattern Selector: A
Stitch Width: 1, no width
Stitch Length: 3
Presser Foot: Even Feed Foot*
Needle Position: Center

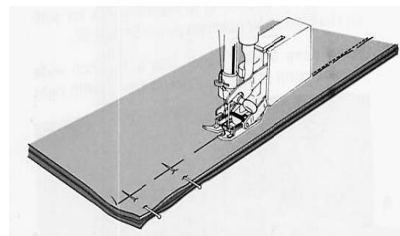

Materials:

(2) 5" x 5" pieces of cotton with batting between the two pieces

Procedure:

◆ Sew from one edge to the other.



The Even Feed Foot is optional. Check with your SINGER® Retailer.

Using the Even Feed Foot to Sew Plaid Fabrics

Machine Set-Up:

Stitch: Straight Stitch
Pattern Selector: A
Stitch Width: 1, no width
Stitch Length: 3
Presser Foot: Even Feed Foot*
Needle Position: Center



Materials:

(2) 5" x 5" pieces of plaid or striped fabric

Procedure:

- ◆ Match plaids, right sides together
- ◆ Sew the two pieces together using the built-in seam guide on the machine to maintain a consistent seam allowance.

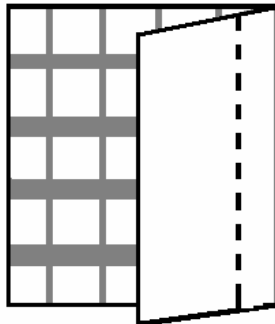

*The Even Feed Foot is optional. Check with your SINGER® Retailer.

Using the Even Feed Foot to Sew Pile Fabrics

The Even Feed Foot is great for sewing on fake fur for coat accents, costumes or stuffed animals.

Machine Set-Up:

Stitch: Straight Stitch
Pattern Selector: A
Stitch Width: 1, no width
Stitch Length: 3
Presser Foot: Even Feed Foot*
Needle Position: Center



Materials:

(2) 5" x 5" pieces of fake-fur

Procedure:

- ◆ Sew the two pieces together using the built-in seam guide on the machine to maintain a consistent seam allowance.
- ◆ Push the fur into the seam.

*The Even Feed Foot is optional. Check with your SINGER® Retailer.

Sewing with the Side Cutter

The side cutter is an attachment that will trim the excess fabric while sewing. A Zigzag-type stitch must be used.

Machine Set-Up:

Stitch: Zigzag
Pattern Selector: A
Stitch Width: 5
Stitch Length: 1-2
Presser Foot: Side Cutter*
Needle Position: Center

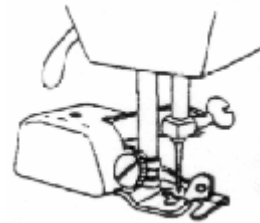

Materials:

(2) 5" x 4" pieces of wool type fabric



Procedure:

- ◆ Cut a 1" x 1" notch in the fabric.
The cutter's blades "cut" before the needle stitches. Be sure to position the fabric under the needle before beginning to sew.
- ◆ Place the fabric OVER the first metal platform and UNDER the second metal platform. If the cutter is not cutting, it is usually due to the fabric not being placed OVER the first platform.

View: Looking down at cutter

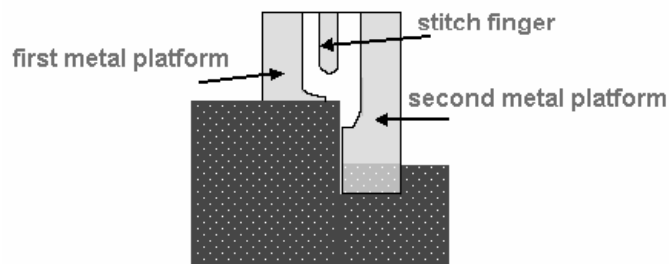

- ◆ Turn the hand-wheel to ensure the the needle does not hit the stitch finger. The stitch width may need to be adjusted.

*The Side Cutter is optional. Check with your SINGER® Retailer.

- ◆ Slowly sew and gently guide the fabric.
- ◆ Adjust the stitch length according to fabric. Certain fabrics will cut better or more cleanly than others. This is due to the nature of the fabric.
- ◆ The cutter works best if not more than 1" is being trimmed away.

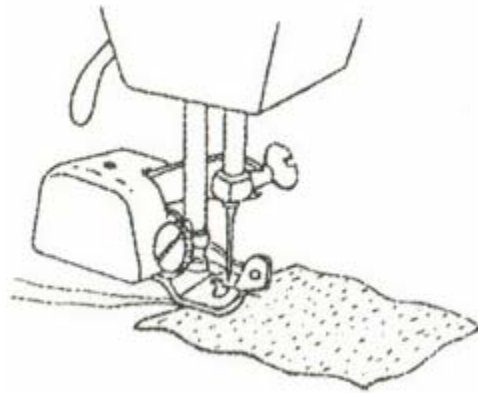

Sewing with the Ruffler

The Ruffler attachment quickly and easily produces professional looking ruffles on garments, home decorating projects and craft items.

Machine Set-Up:

Stitch: Straight Stitch
Pattern Selector: A
Stitch Width: 1, no width
Stitch Length: 7
Presser Foot: Ruffler*
Needle Position: Center

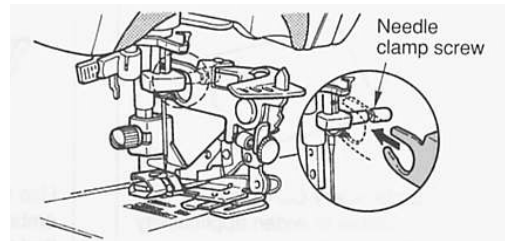

Materials:

3" x 10" piece of lightweight cotton
3" x 5" piece of lightweight cotton

Procedure:

◆ Set the Ruffler for the desired amount of "ruffles".

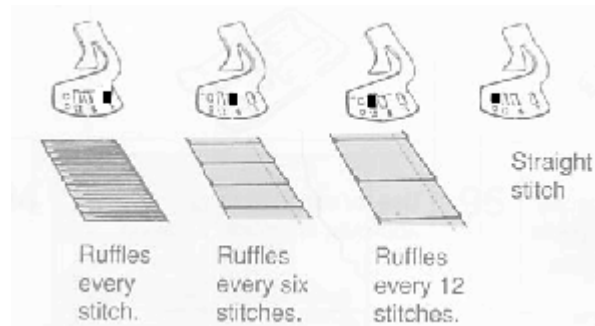

◆ Set the Ruffler for the desired depth of the ruffles.

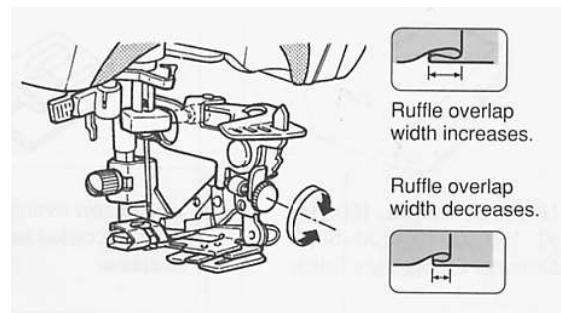

*The Ruffler is optional. Check with your SINGER® Retailer.

- ◆ Place the fabric under the Ruffler. Place fabric in the guide plate.

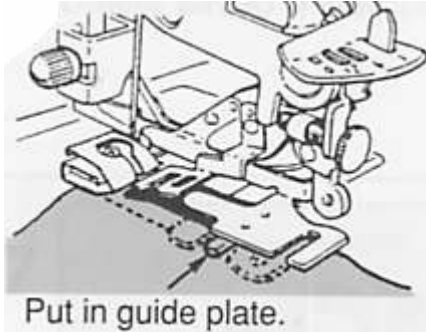

- ◆ Remember to lower the presser foot lever.
- ◆ Lightly push the cloth feed plate towards the back of the machine.

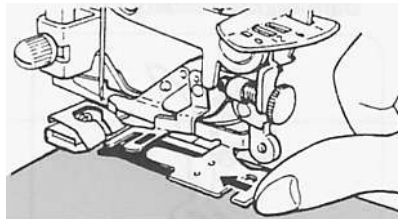

- ◆ Place the longer piece of fabric under the foot and beneath the shorter piece of fabric. Place right sides together.
- ◆ Slowly sew. Watch the Ruffler feed the fabric to make even ruffles. The bottom piece of fabric will feed slower than the top piece.

