

BUTLER

QUILTING ROBOT

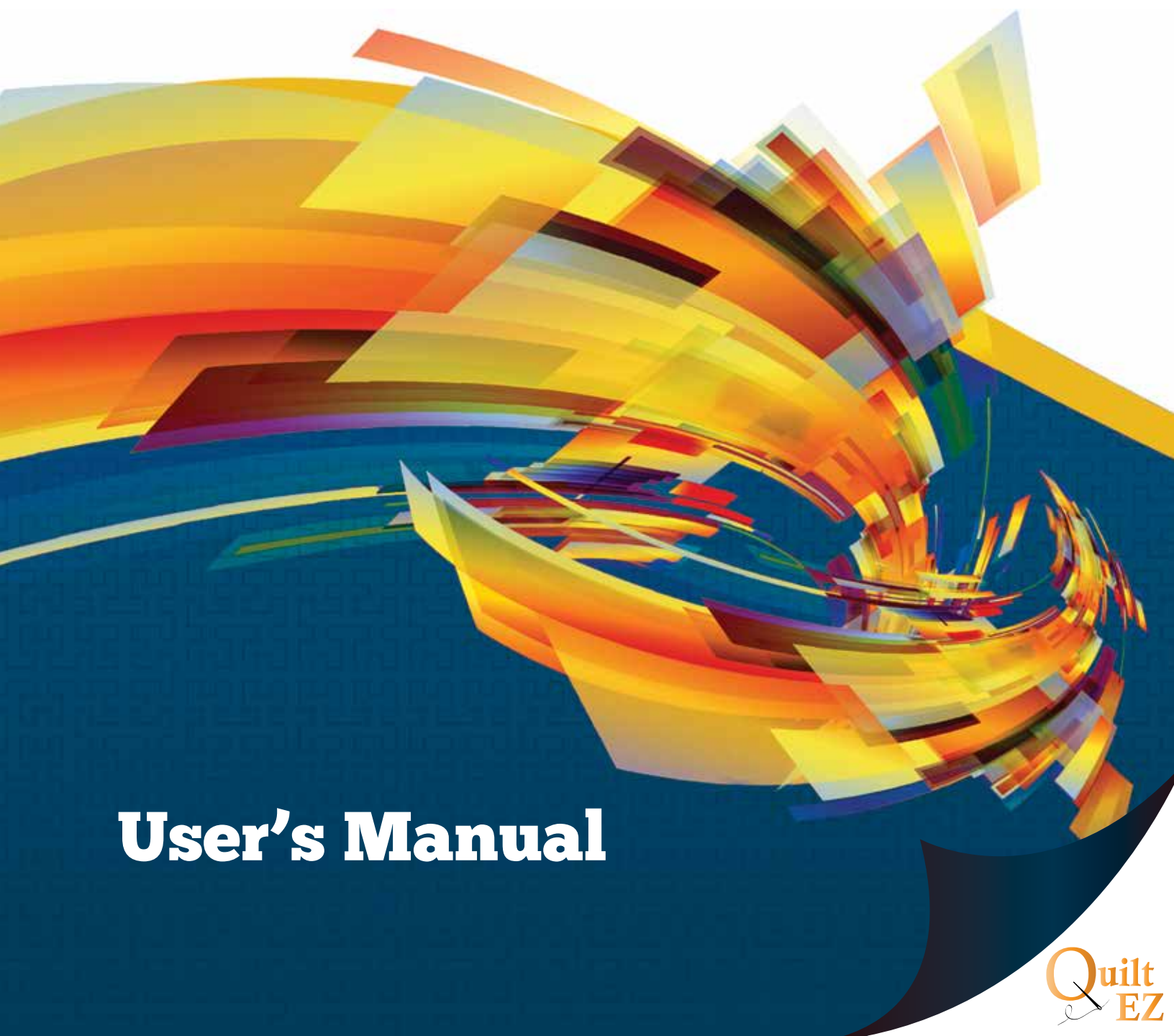

User's Manual

Table of Contents

4	OVERVIEW	19	EDIT
4	Overview	19	Repeat
5	BOTTOM ICONS	19	Move Pattern
5	Pattern Box View	20	Rotate
5	Zoom in/Out	20	Scale
5	Pan	21	Mirror
6	How To	21	Add/Remove Pattern
6	Quilt a quad pattern quilt block	21	Next Pattern
9	Quilt a pantograph-style clam pattern	21	Save Pattern
11	Nest the daisies pantograph pattern	22	Crop
14	HOME	22	Merge
14	Go/Stop	22	Reverse Start/Stop Points
16	Stitch Controller	23	Undo/Redo
16	SPI	24	LAYOUT
16	Horizontal Lock	24	New Layout
16	Vertical Lock	24	Open Layout
17	Angle loc	24	Save Layout
17	Nest	25	Add Pattern Box
		25	Delete Pattern Box
		25	Adjust Pattern Box
		26	Set Quilt Area

27 **FREE MOTION**

27 Record On/Off

27 Save Pattern

28 **FILE MANAGER**

28 Source

29 Filename

29 Destination

30 Copy To

31 **SET UP**

31 Updates

32 Parameters

32 Constants

34 Advanced

37 Test

38 Configuration

39 **STITCH REGULATOR**

39 Sticher User Interface

40 **INFORMATION**

40 Information

41 **DEFINITIONS**

41 Definitions

Overview

Overview of screen layout

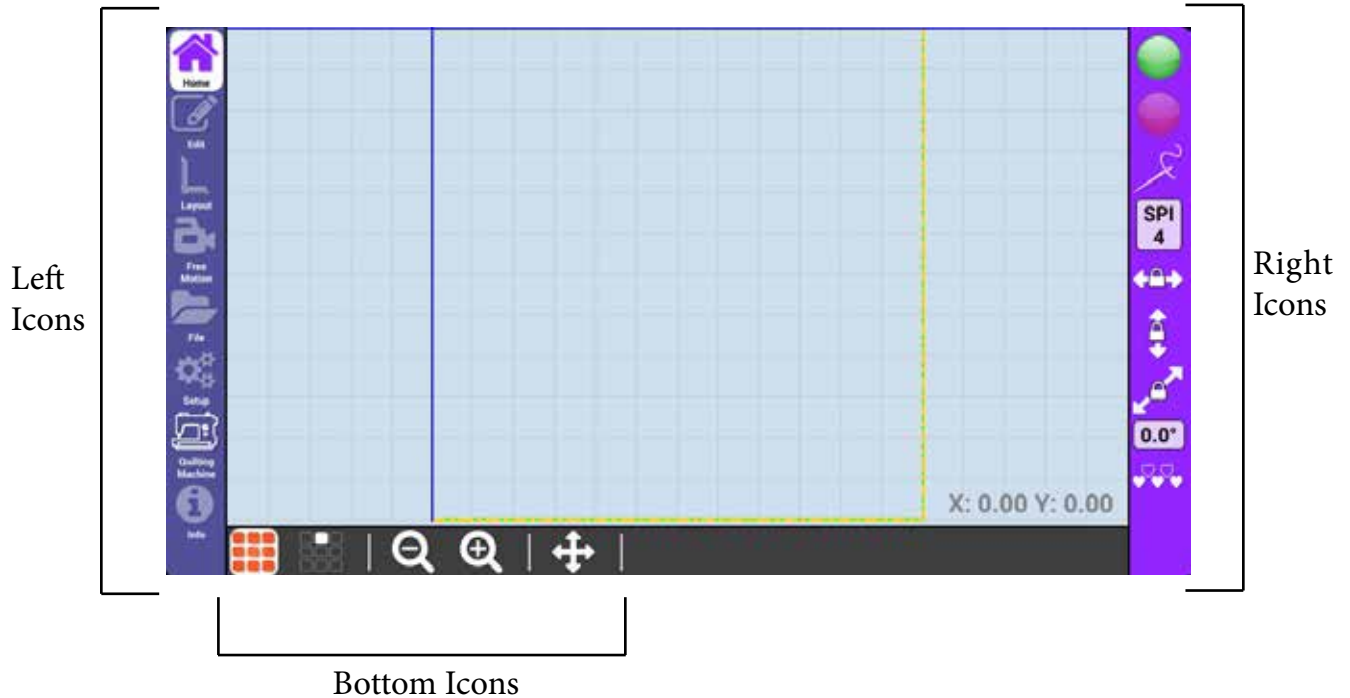

The left icons are used for main navigation.

The right icons correspond with the currently selected left icon.

The bottom icons are always available from any pattern view screen and are explained at right.

Bottom Icons

Pattern View, Zoom, and Pan

Pattern Box View

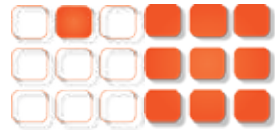

The Pattern Box View lets you choose to see one pattern box at a time or all current pattern boxes.

Zoom Out/In



Zoom Out/In lets you control the zoom level of the pattern view screen.

You can use android pinch gestures to zoom in and out.

Pan



Pan lets you pan the pattern view screen.











To Pan, touch the pan icon, and then press and drag your finger on the screen.

Press the Pan icon again to disable Pan.

How To

Get started quilting quilt blocks and pantograph-style patterns

Quilt a quad pattern quilt block

1. Go to layout  on left navigation.
2. Press new layout .
3. Press green check  on notification screen.
4. Move machine to top-left corner of quilt area and press green plus .
5. Move machine to bottom-right corner of the quilt area and press green plus  then press OK.
6. Press add pattern box .
7. Draw a pattern box 12 inches by 12 inches. (A pattern box is usually a traced quilt block. For more about pattern boxes, see page 41.)
 - 7a. To draw a pattern box, position the machine at the first corner of the block, and press the green plus . Move in a clockwise or counter clockwise motion to create each corner of the square pattern box. At each corner, press the green plus . At the last corner, press the green checkmark . (The coordinates at the bottom right of the screen show your needle position in inches. You can use the coordinates to help you measure the square box.)
 - 7b. If the pattern box dimensions aren't correct, you can redraw the pattern box by pressing adjust pattern box .

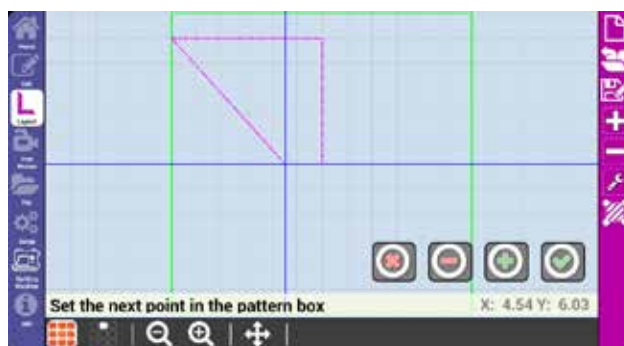
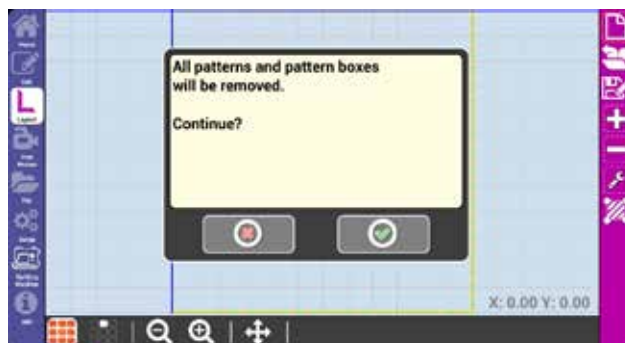

8. Select pattern box view  at bottom left of screen.

9. Navigate to new pattern box  2/2.

10. Go to Edit  on left navigation.





11. Press add pattern .

12. Open the blocks folder.

13. Select the budding blocksjs061 pattern and press select pattern.



14. Press select pattern. (You should see large circles around the edges.)

15. You should see large circles around the edges. (If not, touch the pattern.) Touch the center circle of the pattern and drag it to the top left corner of the pattern box.



15a. If you need to fine tune the placement, press move  and use the movement arrows     to get it just right.

16. Press rotate .

17. Press 45° to the right .

17a. You can also fine tune the rotation using the green plus  and red minus  buttons .

18. Press repeat .

19. Press the horizontal green plus  and the vertical green plus  to repeat the pattern 2x2.









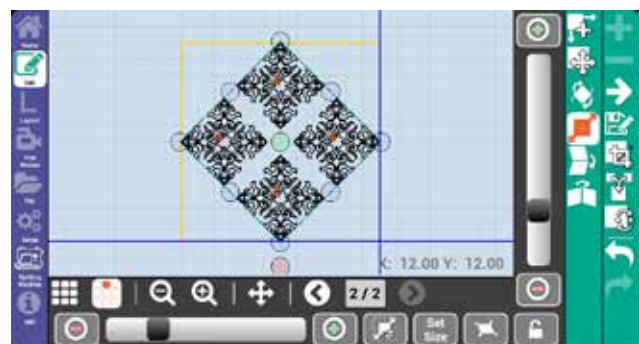
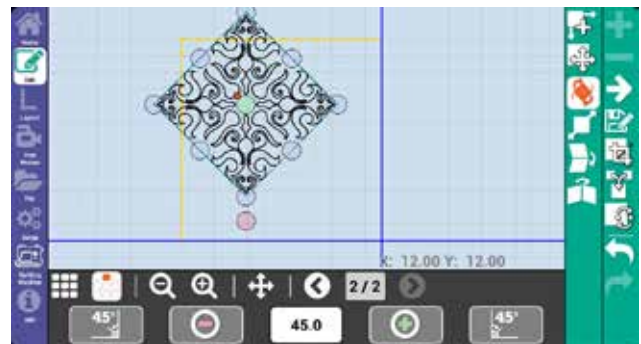
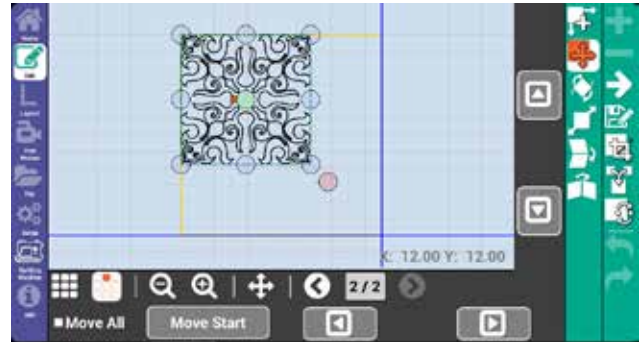

20. Touch the 0.0 number box for horizontal spacing and set it to 1.0.

21. Touch the 0.0 number box for vertical spacing and set it to 1.0.

22. Press scale .







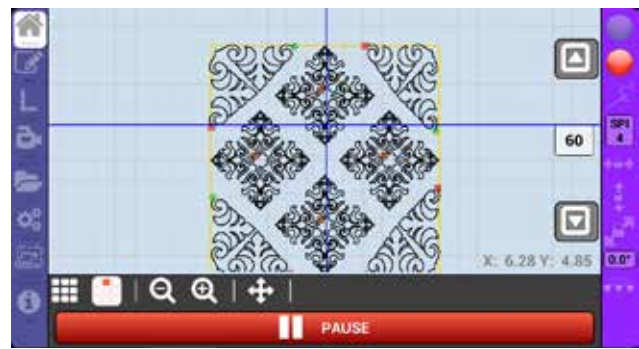
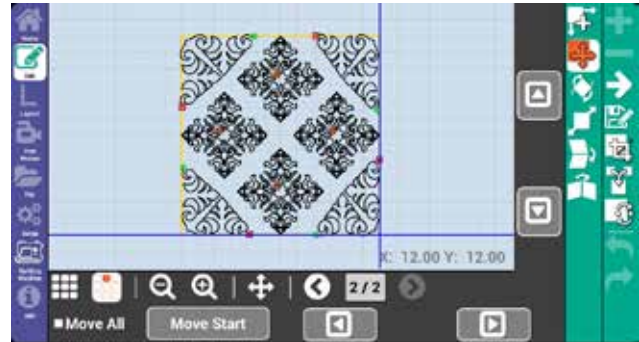







23. Press the smart scale button . (Found at the bottom of the screen.)











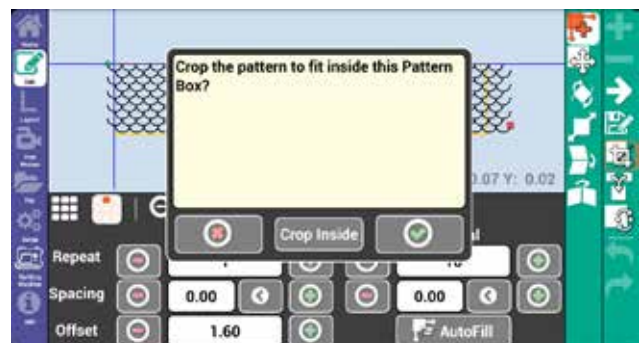
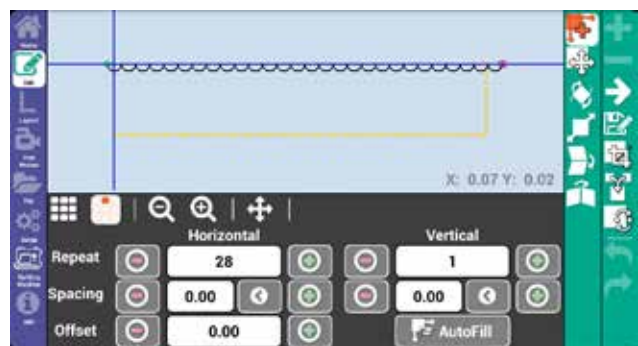
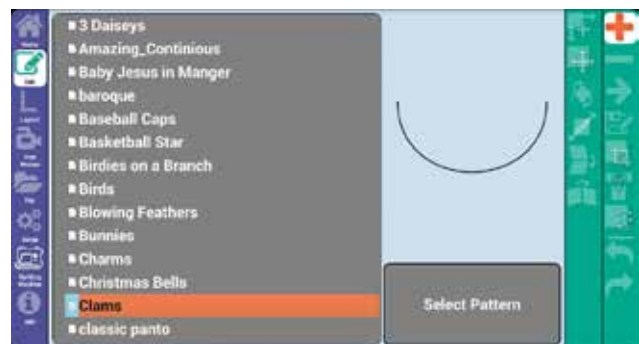
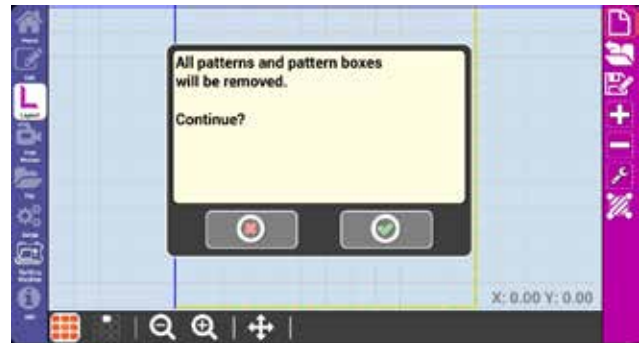





24. Press scale  again to de-select the scale menu.
25. Press add pattern .
26. Select Corners > JMPANTO001C PYRAMID CRN and press select pattern.
27. Resize and rotate the corner pattern to fit into a corner of the pattern box.
28. Repeat steps 25-27 until all corners are filled.
29. Go to home  on the left navigation.
30. Press the green go button .
31. After verifying that the needle is in the up position, press the green checkmark .
32. Press the green checkmark . The pattern should now trace without stitching. (This is a trial run to make sure that the pattern stitches where desired.)
33. Press the red stop button .
34. Press the stitch controller  to highlight it.
35. Press the green Go button .
36. Press the green checkmark . Pull up the bobbin thread, then press the green checkmark .



Quilt a pantograph style clam pattern







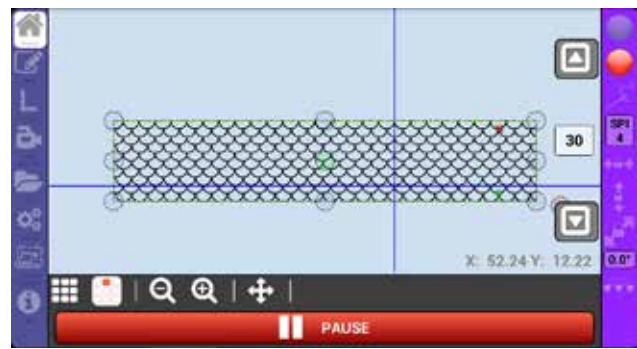
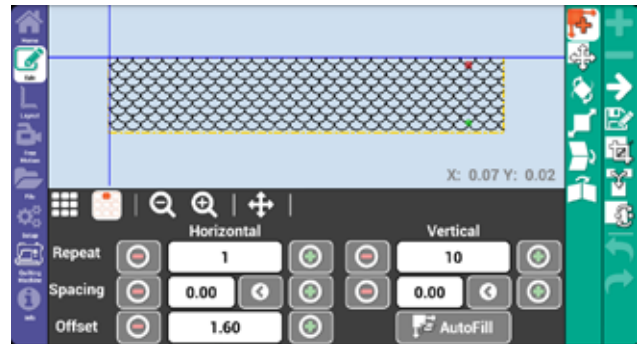



1. Go to layout  on left navigation.
2. Press new layout .
3. Press OK  at notification screen.
4. Move machine to top-left corner of quilt area and press green plus .
5. Move machine to bottom-right corner of the quilt area and press green plus .
6. Go to Edit  on left navigation.
7. Press add pattern .
8. Go to Pantos > Clams and press select pattern.
9. Move the machine so that the needle is at the top left corner of your quilt area.
10. Press move  then press Move start, then press the green checkmark .
11. Move the pattern so that half of the clam is off the left edge of the pattern box. (If you need to fine tune the placement, press move  and use the movement arrows  to get it just right.)
12. Press repeat .
13. Repeat the pattern horizontally (press the horizontal repeat plus ) until it spans just past the right edge of the pattern.
14. Press merge  to merge the repeated clams.
15. Repeat the clams vertically (press the vertical repeat plus ) until just before the bottom edge of the pattern box.











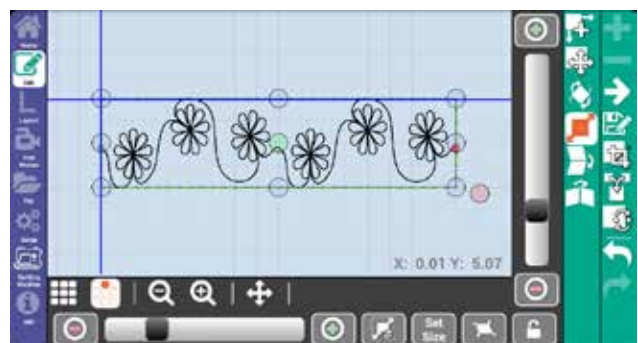
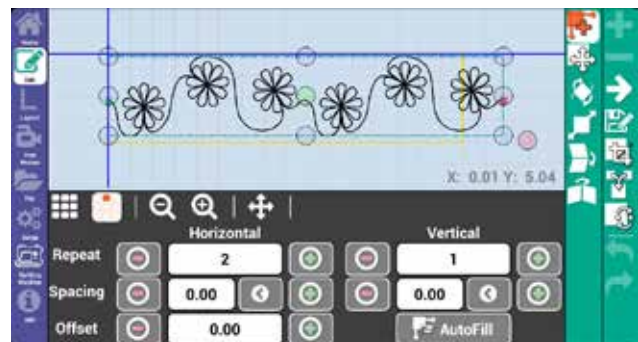
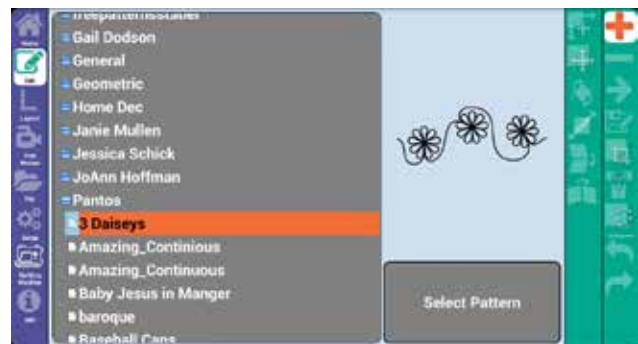



16. Press the offset green plus  as desired to stagger the clam rows.
17. Press merge  to merge the repeated clam rows.
18. Press crop , then press the green checkmark .
19. Press scale , then press smart scale .
20. Go to home  on the left navigation.
21. Press the green go button , check that your needle is in the up position, then press the green checkmark . (This is an optional trial run to ensure the pattern is positioned correctly and will stitch exactly where you would like.)
22. When you are satisfied that the placement is correct, press the red stop button .
23. Touch the stitch controller  to highlight it.
24. Press the green go button , check that your needle is in the up position, then the green check mark .
25. Pull up the bobbin thread, and press the green checkmark .
26. Stay with the machine to cut the thread at each endpoint on the edges of the pattern box.





Nest the daisies pantograph pattern

1. Go to layout  on left navigation.
2. Press new layout .
3. Press OK  at notification screen.
4. Move machine to top-left corner of quilt area and press green plus .
5. Move machine to bottom-right corner of the quilt area and press green plus .
6. Go to Edit  on left navigation.
7. Press add pattern .
8. Go to Pantos > 3 Daiseys and press select pattern.
9. Move the machine so that the needle is near the top right corner of your quilt area.
10. Press move  then press Move start, then press the green checkmark .
11. Move the pattern so that the top left corner of the pattern matches the top left corner of the quilt area.
12. Press repeat .
13. Repeat the pattern horizontally (press the horizontal repeat plus ) until it spans just past the right edge of the pattern. (Note that you will probably repeat it many more times than shown at right.)
14. Press scale and press smart scale to stretch the pattern to fill the quilt area. (If you wish to prevent distortions of the pattern, press the lock button at the bottom right of the scale menu.)

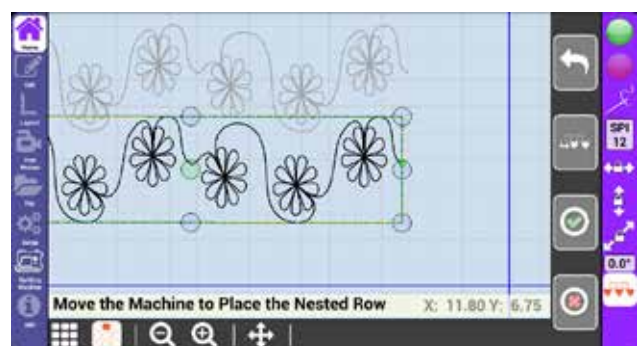
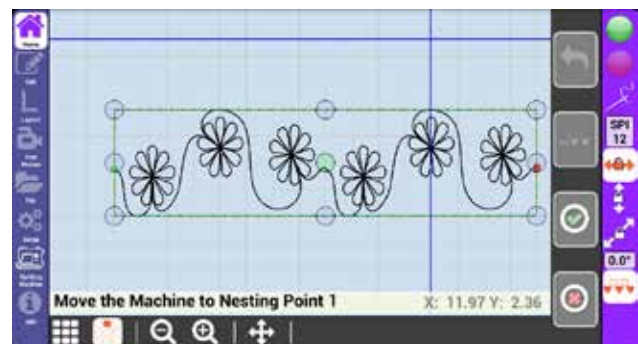
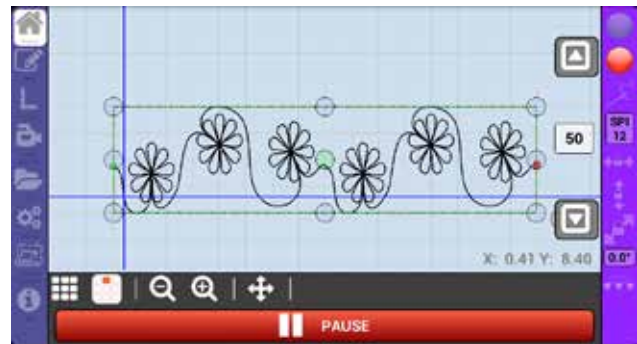
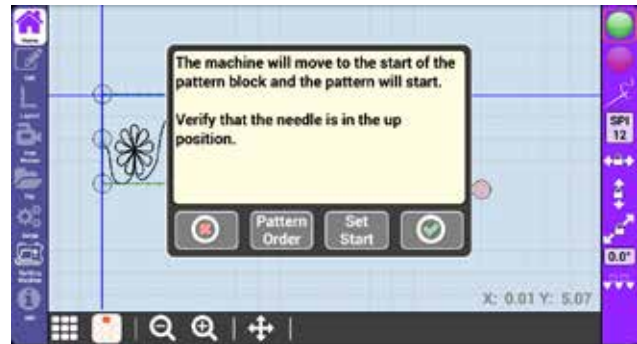

1. Go to home  on the left navigation.
2. Press the green go button , check that your needle is in the up position, then press the green checkmark . (This is an optional trial run to ensure the pattern is positioned correctly and will stitch exactly where you would like.)
3. When you are satisfied that the placement is correct, press the red stop button .
4. Touch the stitch controller  to highlight it.
5. Press the green go button , check that your needle is in the up position, then the green checkmark .
6. Pull up the bobbin thread, and press the green checkmark .
7. Once that pattern is stitched, go to Home  and press nest .
8. You will now select two nesting points. Move your machine so that the needle is directly above any point on the just stitched pattern (preferably on the left side).
9. Mark this point on the fabric (with quilters chalk or something similar) and then press the green check mark .
10. Repeat steps 8-9 to mark the 2nd nesting point (preferably on the right side.)
11. Roll your quilt, then press the green checkmark .



12. Move the machine to the first nesting point, press the green checkmark , then move the machine to the second nesting point and press the checkmark .

13. Move the machine to position the pattern, then press the green checkmark . (The bottom pattern represents where the new pattern will be stitched and the grey pattern represents where the pattern has already been stitched.) The pattern is now nested and ready to be stitched.

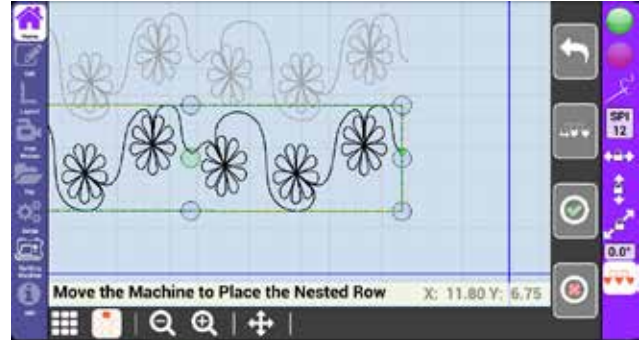

Home



Start and Stop Butler, Set Stitch Regulation, Belt Locks, Nest

Go/Stop



The green Go button will move the machine and follow the pattern in the currently selected pattern box.

The red Stop button will immediately stop any follow and return you to the pattern display screen.

How to trace a pattern (no stitching)

If you press the Go button when the Stitch Controller is not highlighted, then your machine will not be stitching during the pattern trace.

How to stitch a pattern

If you press the Go button when the Stitch Controller is highlighted, then your stitching regulator will be engaged and stitching during the pattern trace.

A notification asking you to verify that the needle is in the up position will appear and display four options.

Cancel will return you the previous pattern view screen.

Pattern order will let you set the order each pattern will be stitched. (by default, the patterns are stitched in the order they are added.)

Stop
Go

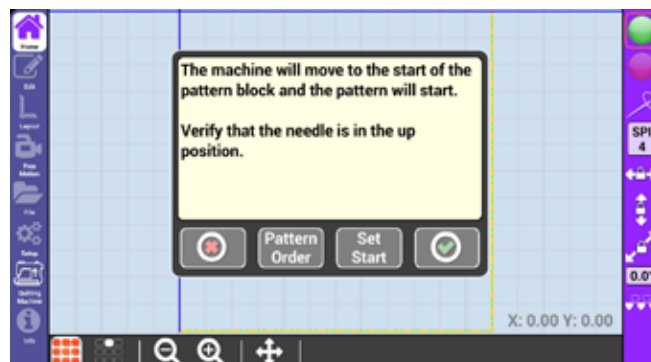
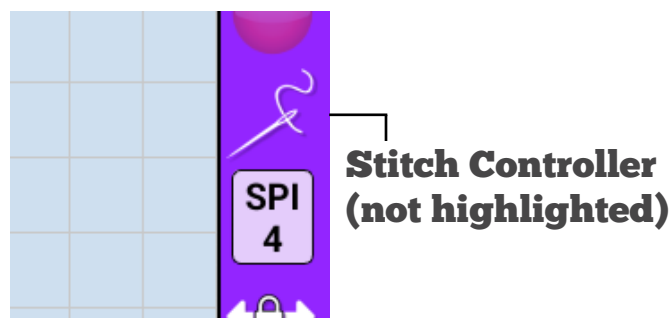
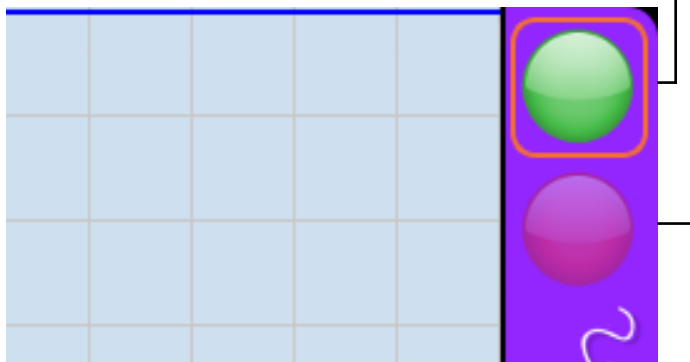

Set Start allows you to set the start position on the pattern. This is useful if you need to resume a pattern that has only been partially stitched, such as a pattern that had a thread break.

OK will proceed to follow the pattern.

After you press OK, your machine will reposition the needle to be over the start position of the first pattern on the pattern box and perform a needle up. A notification will prompt you to pull up the bobbin thread. Press Cancel to return to the pattern view, or Press OK to have the machine begin following the pattern.

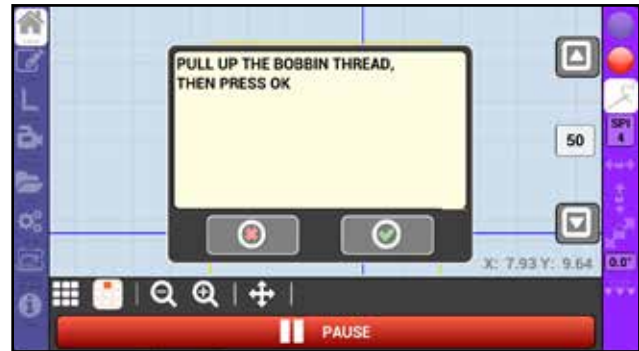

While the machine is following the pattern, you can adjust the speed by using the up and down arrows on the right of the screen. The lower the speed, the slower the system will move. (The speed defaults to the max speed settings in the Setup Parameters tab.)



During the trace, you may need to stop your machine. (For example, if you have a thread break or your bobbin runs out of thread.)

To stop the machine, press pause.

To start the machine again, press start.

If you had a thread break, press thread break and follow the on-screen prompts to begin where the thread break left off. For best results, it is recommended to resume the trace just before the thread break.

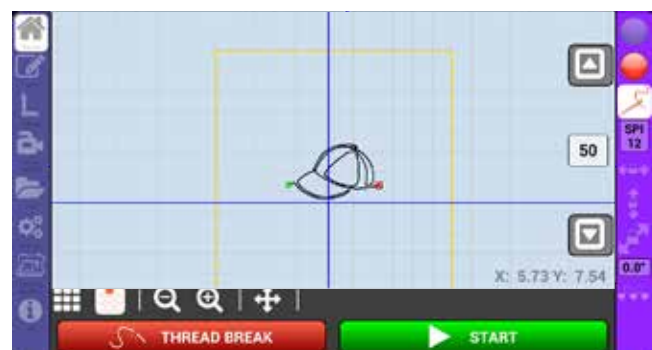

Stitch Controller



When the Stitch Controller is highlighted, any trace performed using the green Go button will stitch during the trace.

When the Stitch Controller is not highlighted, any trace performed using the green Go button will not stitch during the trace.

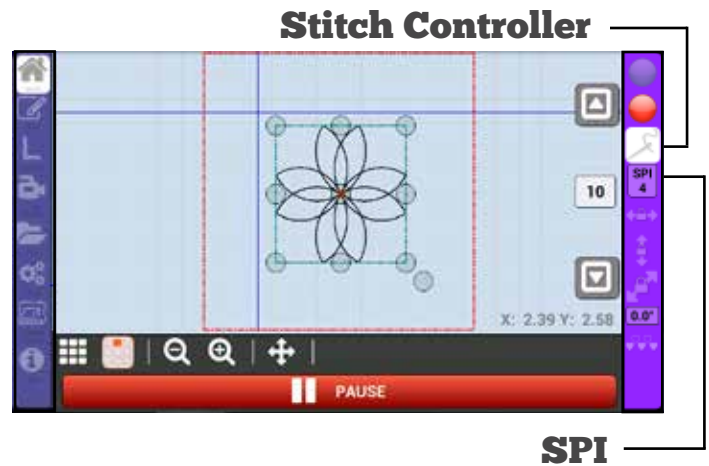

SPI



You may see an SPI, or stitches per inch, icon below the Stitch Controller button. (This setting is not compatible with all machines.)

SPI allows you to adjust the stitches per inch setting of select stitch regulators.



Horizontal Lock



Horizontal Lock locks the horizontal, or left and right, movement of the carriage. This can be used, among other things, to help you draw straight horizontal lines.

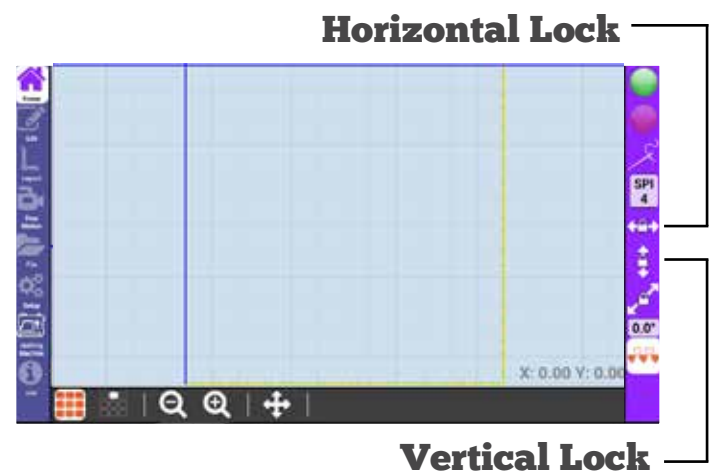

Vertical Lock



Vertical Lock locks the vertical, or front and back, movement of the carriage. This can be used, among other things, to help you draw straight vertical lines.

Angle Lock



Angle lock allows you to set any angle, out of 360 degrees, that you would like to lock the machine.

Touch the 0.0° icon to set the angle at which you desire to lock the movement of the machine. (Note that negative values are acceptable to create inverse degree angles.)

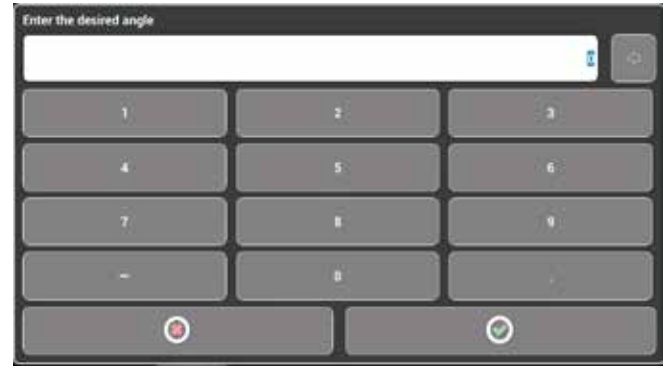

Nest



Nest allows you to nest a pattern below a stitched pattern on your quilt area. This involves rolling your quilt to make room for the new pattern.

How to nest a quilt pattern

1. To nest your pattern, Follow the on-screen prompts and move your machine to the bottom left corner of your quilt area, mark the quilt top with fabric chalk or something similar, then, with the needle over that mark, press the green check mark.
2. Repeat step 1 for the right side.
3. Once both locations have been marked, roll your quilt. Ensure the marked points remain visible.

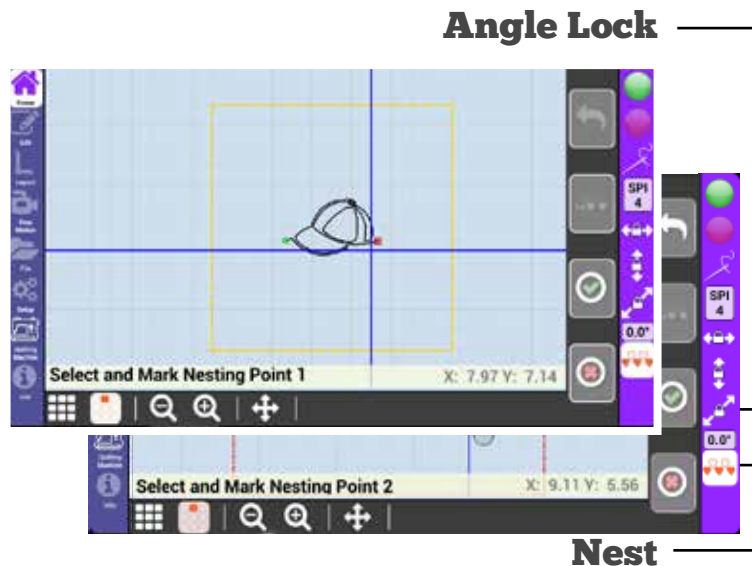

4. Once the quilt is rolled, follow the on-screen instructions to realign your machine with both the left and right marks created in step 1 and 2, and press the green check mark. (If you press the check mark at the incorrect point, use the undo button to try again.)



5. You should now see two patterns on the screen. One of these patterns represents the pattern you have already quilted onto your quilt top. You can nest the pattern in one of two ways. Either press the nesting indent icon and set the desired vertical distance between the quilted pattern and the to-be quilted pattern, or move the machine head to position the to-be-quilted pattern where you would like it to nest with the quilted pattern. Then, press the check mark button.

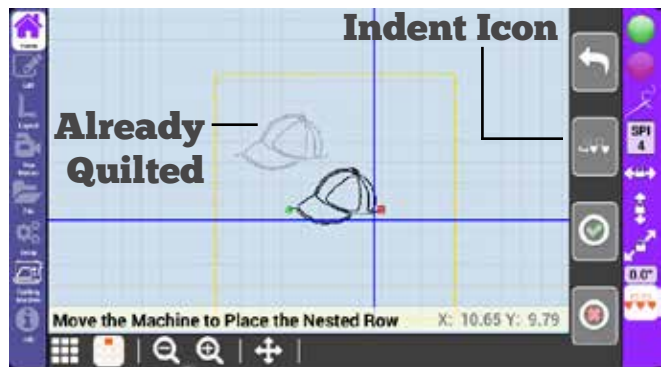

6. Press the green Go button on the home screen to stitch the pattern as normal.



Edit



Add, remove, and edit patterns for a layout.

Repeat



Repeat allows you to repeat the currently selected pattern vertically and horizontally. Repeat also gives you control over pattern spacing, and can offset rows of repeated patterns.

The left arrow icon for spacing allows you to automatically align the start and end points of repeated patterns. This is most useful when repeating horizontally.

Autofill will automatically fill as many of the pattern as possible into the pattern box.

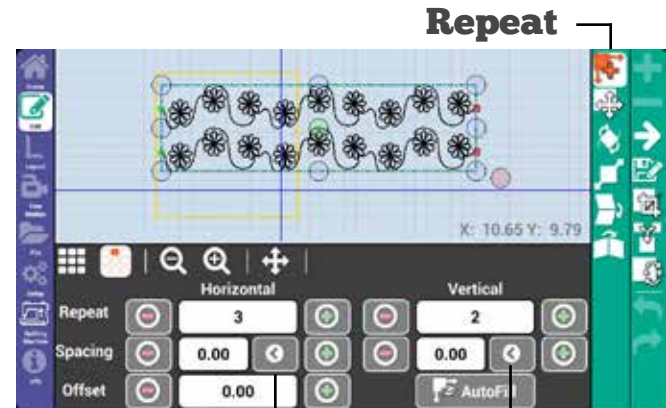

Left Arrow Icon

Move Pattern



Move allows you to move the currently selected pattern. Press the up/down and left/right arrows to move the pattern on the screen.

You can also touch and drag the center circle of the currently selected pattern to move it.

Check move all to move all the patterns at once. Move start uses the machine needle to pinpoint where you would like to move a pattern. The start point of the moved pattern will match wherever the needle is on the quilt top.

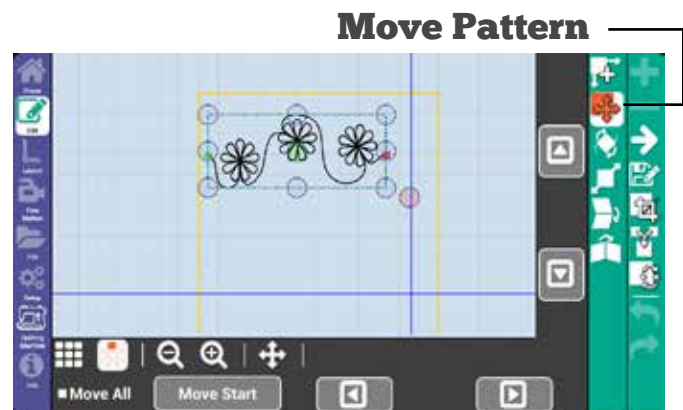

Rotate



Rotate allows you to rotate the currently selected pattern. Press the 45° icons to rotate left or right, press the plus and minus to rotate by single degrees, or press the numbers in the center to input a specific degree of rotation.

Alternatively, you can touch and drag the red circle at the lower right of the selected pattern.

Move Pattern

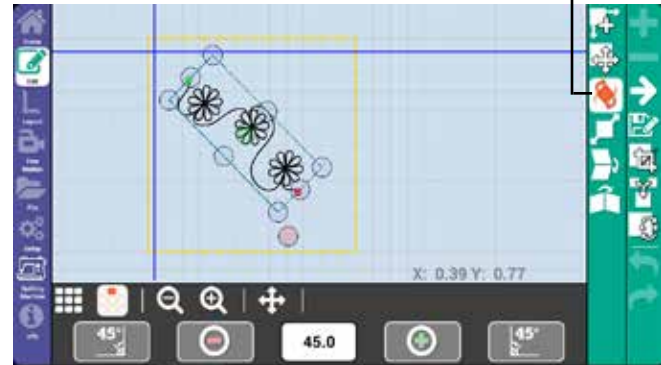

Scale





Scale allows you to scale the currently selected pattern.

You can scale the pattern by using the plus and minus buttons or the scoll bars in the scale menu. You can scale the pattern by pressing the Set Size button, then enter the width and height when prompted, or touch and drag the corners of the currently selected pattern.

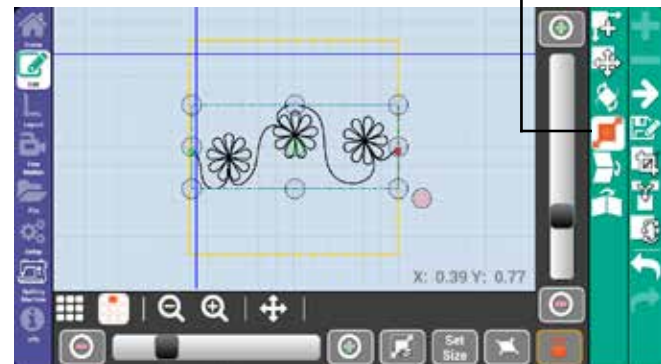
Scale



Smart scale  will automatically scale the pattern to as large as possible while staying inside the pattern box.

Morph  allows you to fill any four sided pattern box with the selected pattern. The pattern will distort to fill the pattern box if the pattern box isn't exactly square.

The lock icon  will constrain pattern proportions while scaling. This doesn't apply to Morph.

Mirror



Mirror allows you to flip the selected pattern vertically or horizontally.

Add/ Remove Pattern



Add a pattern to the quilt area. Select a pattern from the left menu, then press Select Pattern to add it to the current pattern box.

Remove pattern will remove the currently selected pattern from the pattern box.

Next Pattern



Next will select the next available pattern. The patterns are selected in the order in which they are added to the pattern box.

Save Pattern



Save allows you to save the currently selected pattern, and any changes you may have made, under a new name. Saving a pattern with its original name overwrites the old pattern. The pattern is saved below the folders of the pattern select screen.

Mirror

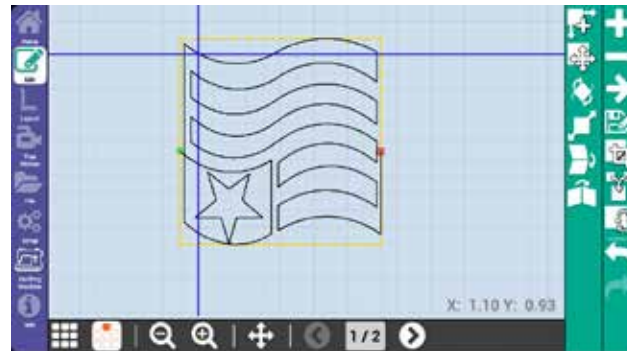
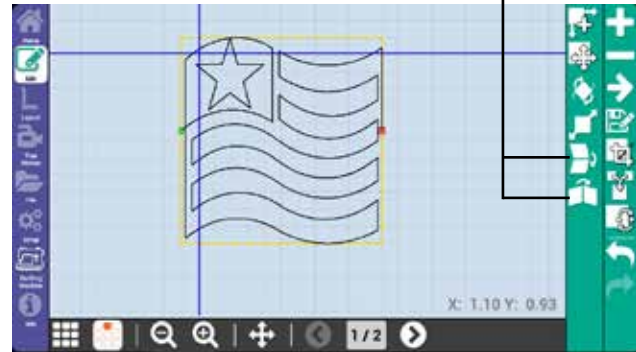

Add/Remove Pattern

Next Pattern

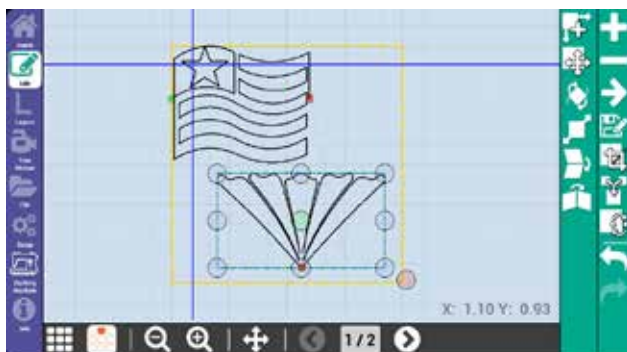
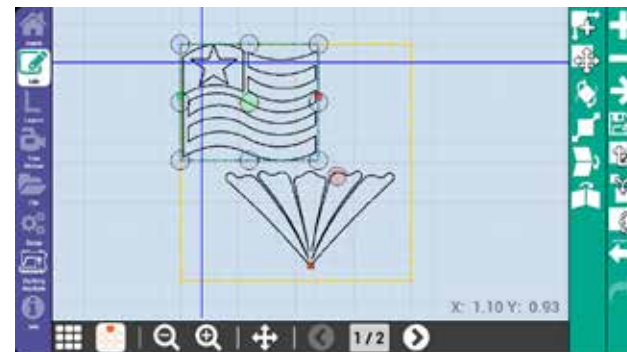

Save Pattern

Crop



Crop allows you to edit a pattern that overlaps the edge of a pattern box. When you press crop, a dialog box appears with options to cancel, crop inside, or press the green check mark.

The green check mark will crop and delete all of the pattern that is outside the pattern box.

Crop inside will crop and delete all of the pattern that is inside the pattern box.

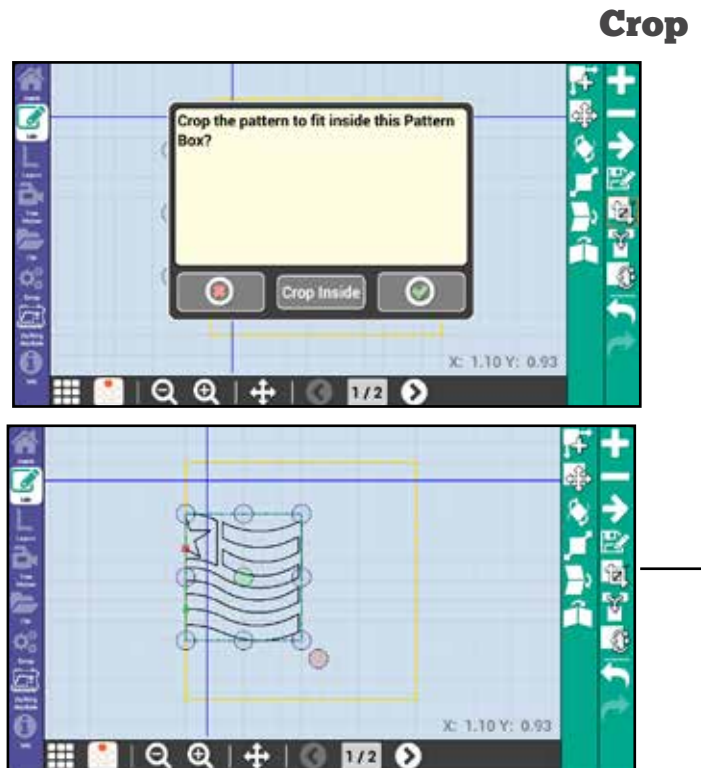

Crop

Merge



Merge allows you to merge all the patterns in the pattern box into one. This can be useful when saving a repeated pattern as a new, renamed pattern.

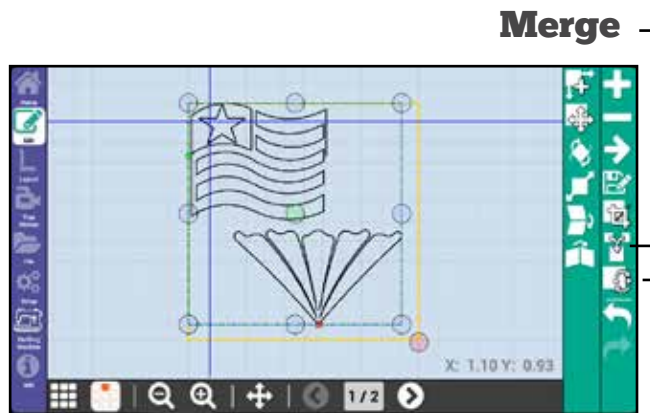

Merge

Reverse Start/ Stop Points





Reverse Start/Stop Points allows you to swap the start and end points of the currently selected pattern. This will reverse the direction in which the pattern is stitched.

Reverse Start/Stop Points

Undo/Redo



Undo  allows you to undo actions you take while designing your quilt, including moves, transformations, and repeats of your patterns.

Redo  will repeat any undone actions.

Undo/Redo

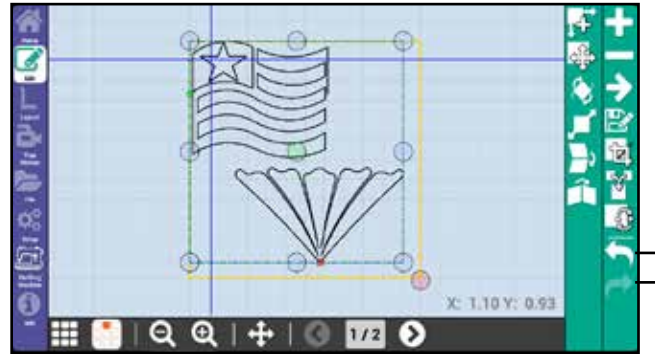

Layout



Create, save, and open layouts. Adjust quilt area and pattern boxes.

New Layout



New Layout creates a new, clear layout to which you can add patterns and pattern boxes. (A layout is usually used to save all the work on your current quilt project. A layout consists of all pattern boxes, and patterns used in a project, and saves their relative size and spacing.)

Open Layout



Open layout lets you open saved layouts which contain pattern boxes and patterns.

After opening a layout, you will be prompted to move the machine head to the top left corner of your quilt frame quilt area and press ok. (To keep the layout consistent, this home position should be the same position that was used for the layout when it was originally created.)

Save Layout



Save Layout lets you save your currently open layout. (If you save the layout with it's old name, it will overwrite the existing layout file.)

Open Layout
New Layout

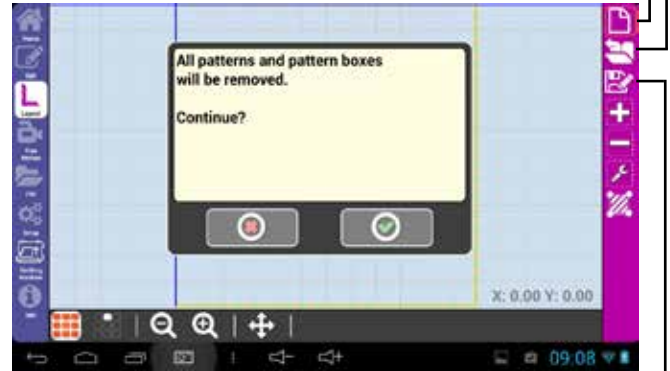



Save Layout



Add Pattern Box



Add pattern box will add a new pattern box to the layout.

When you press add pattern box, you will see three buttons: a red “X”  to cancel, a green plus  to add a point to define the pattern box, and a green checkmark  to place the last pattern box point, finishing the pattern box.

After you place the first point, a red minus button will appear that can be used to remove points that define the pattern box, starting with the most recently placed.

How to make a two-point pattern box

Rather than mark each point of a square or rectangle pattern box, you can simply mark the two diagonal corners. This will produce a perfectly square pattern box with even lengths and heights.

while this is a quick solution, if your quilt block isn't exactly square, the stitched pattern may not line up properly.

Delete Pattern Box



Delete Pattern Box will remove the selected pattern box from the layout and all patterns inside of it.

Adjust Pattern Box



Adjust Pattern Box allows you to redefine the borders of the currently selected pattern box. Press the Adjust Pattern Box icon, then follow the same procedure of adding a new pattern box to redefine the pattern box.

Add Pattern Box

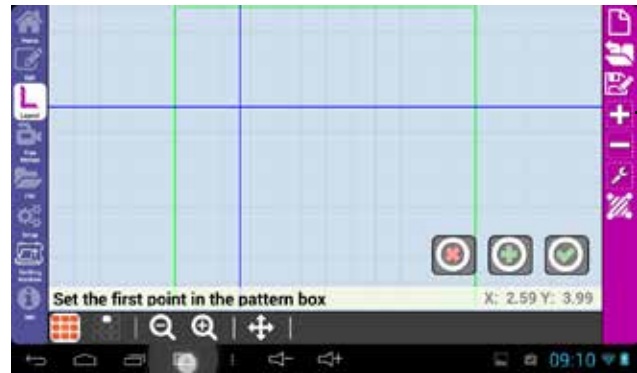

Remove Pattern Box

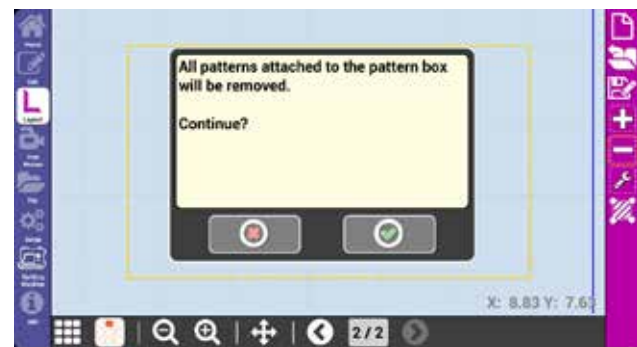

Adjust Pattern Box

Set Quilt Area



Set quilt area will reset your quilt area. Pressing the green checkmark will let you reset the dimensions of your quilt area. (This is commonly used when you need to stitch the last row of a quilt that has slightly different dimensions than the previously stitched rows.)

Set home will keep the current dimensions of the quilt, but let you use the home point—or top left corner of the

Open Layout New Layout



Free Motion



Record and save freemotion quilting

Record on/off



Record on/off toggles the record feature of Butler. Press it once to activate free motion record. Move the machine head to draw your recorded free motion design, then press it again to stop recording.

Save Pattern



Save pattern will save your recorded pattern into the root folder of the pattern files. (The root folder is the first or top-most directory in a hierarchy. Think of it as the three trunk for all the other folders, or the starting point from which the other files originate.)

Remove Pattern Box

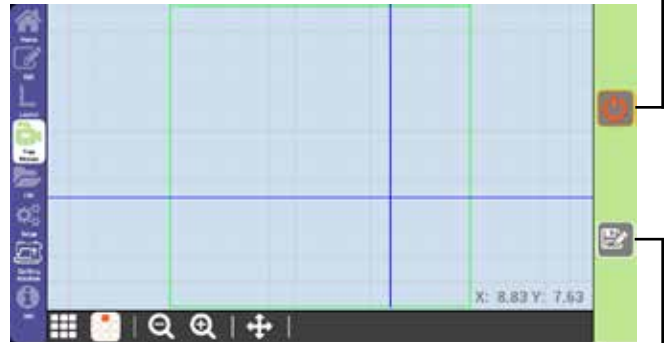

Remove Pattern Box

File Manager



Copy, delete, and move files

File Manager is used to copy files from one location to another and to delete files you no longer need.

Source

Source sets the memory source, either internal or USB, from which to copy or delete files and folders. In other words, this is where the patterns are coming from, not where they are being saved to.

Internal

If internal is selected, then your files will be saved to Butler's internal memory.

USB

If USB is selected, then your patterns will be saved to the inserted USB stick.

Previews

To decrease pattern preview load times, pattern previews are saved as image files. The blue file button allows you to manage preview images.

Previews are saved on internal memory.

Preview image files that have already loaded are not updated if a pattern is modified. To update the preview image, delete the preview image file. Once the preview image has been deleted, the preview image will update automatically when viewed.

(when overwriting a pattern, delete the patter first then upload it. This ensures the old preview is also deleted.)

Source

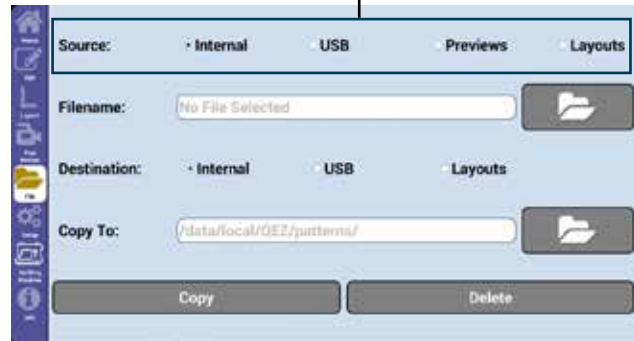

Layouts

Layout allows you to manage all of your saved layouts.

Layouts are saved on internal memory.

Filename

Filename shows you the currently selected file, if any.

File Button

The file button to the right of Filename allows you to manage the files and/or folders from the source radio button options.

The file button menu contains the New Folder, Cancel, and OK buttons. New Folder creates a new folder in the currently selected folder, Cancel returns you to the previous screen, and OK will load the currently selected file or folder into the Filename field.

Destination

Destination sets the active storage memory type to which files or folders will be copied by pressing the copy button.

Internal

This will set the destination of imported or moved files to Butler's internal memory.

USB

This will set the destination of imported or moved files to the inserted USB stick.

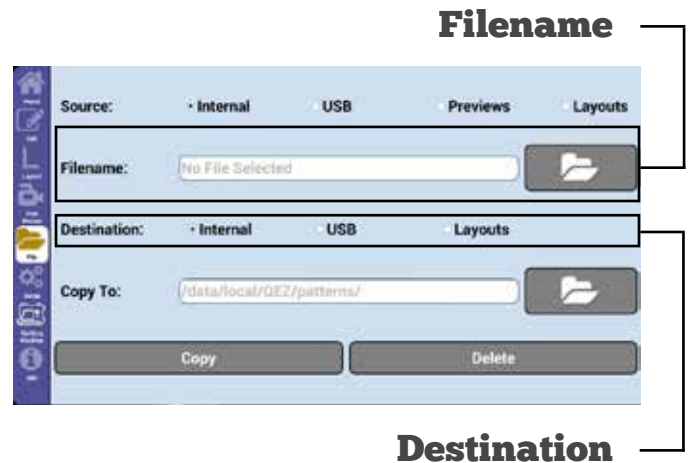

Layouts

This will set the destination of imported or moved layouts to the correct internal folder.

The Layouts checkbox must be checked for imported layouts to be recognized by Butler.

Copy To

Copy To shows you the location on the selected Destination memory type to which the selected Filename file or folder will be copied.

File Button

The file button to the right of Copy To allows you to manage files and/or folders from the currently selected memory source. (For more on storage Source, see source on page 27.)

The blue file button menu contains the New Folder, Cancel, and OK buttons. New Folder creates a new folder in the currently selected folder, Cancel returns you to the previous screen, and OK will load the currently selected file or folder into the Filename field.

Copy

Copy will copy the selected Filename file or folder to the selected Copy To folder.

Delete

Delete will delete the selected Filename file or folder. As delete cannot be undone, always exercise caution when deleting files.

Copy To



Setup

Manage updates, constants, and machine specific settings

Updates

The Updates tab allows you to verify the version of the display, robot, and machine, to run updates, to calibrate your display screen, and to set your motor direction based on its mounting orientation.

System Info

System Info shows you your current display, robot, and machine versions, as well as other licensing information.

Update Robot

Update robot allows you to run updates of the robotics via a USB stick. Update files may be provided by an authorized Quilt-EZ dealer.

Motor Forward (Motor Reversed)

Motor Forward (or Motor Reversed) is used to reverse the direction that the Motor pulleys turn. Forward is used if the Motor Box is mounted to the carriage front, while Reversed is used when the the Motor Box is mounted on the back of the carriage.

The displayed name on the button indicates the current direction the motor is running.

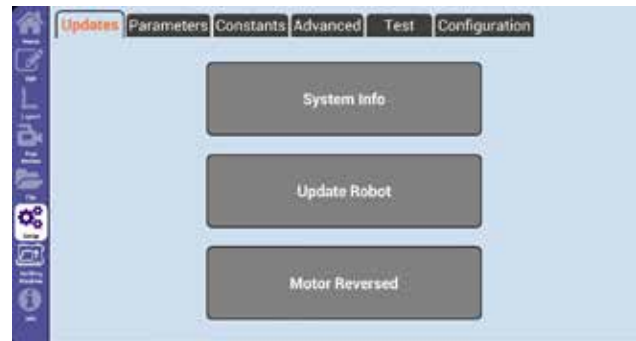

Parameters

Max Speed

Max Speed sets the maximum speed at which Butler will run. This will show as the default speed when you press Go.

Min Speed

Min Speed sets the minimum speed at which Butler will run. We recommend that this setting only be changed under the direction of an authorized Quilt-EZ dealer.

Lock

Lock sets the number of lock stitches, or tie offs, that Butler will use at a pattern stop point.

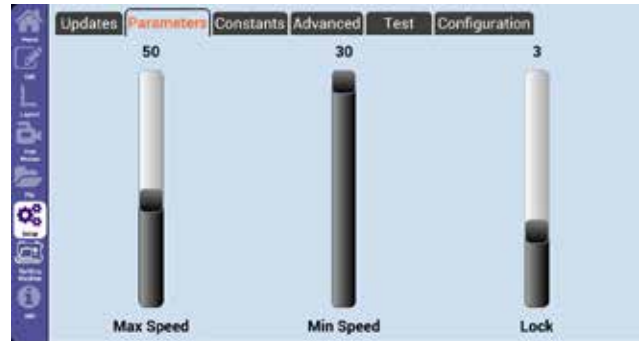

Constants

Constants allows you to make adjustments to variables used by Butler to properly operate.

Because of their impact on the robotics system, please consult an Authorized Quilt-EZ dealer before adjusting constants.

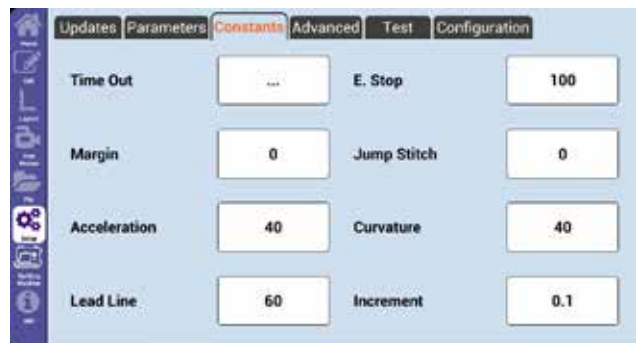

Time Out

Time Out is disabled and has no effect.

E. Stop

E. Stop determines the sensitivity settings for an emergency stop. Emergency stop is a safety feature of Butler. When the machine detects an obstruction to its movement, such as bunched up fabric or a stray object, Butler will automatically stop stitching.

The higher the E. Stop, the less likely Butler will stop because of an obstruction. Adjusting this setting too high may result in torn fabric and broken needles.

Margin

Margin allows you to set the margins, top, bottom, left, and right, that are used for Scale.

Jump Stitch

Jump Stitch sets the distance the machine will allow itself to perform a jump stitch without prompting you to cut the thread or pull up the bobbin thread.

Acceleration

Acceleration sets the maximum rate of acceleration and deceleration used by the robotics.

The number input doesn't match any popular unit of measurement and is unique to Butler.

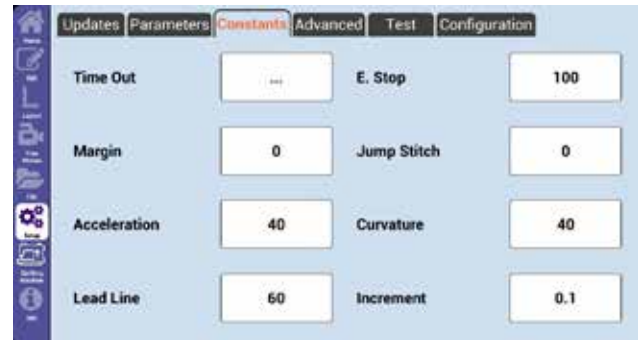

Increasing Acceleration increases the maximum acceleration and deceleration rate, while decreasing the Acceleration decreases the maximum acceleration/ deceleration rate.

Curvature

Curvature sets the maximum speed used by the machine when stitching on a curve.

The number input doesn't match any popular unit of measurement and is unique to Butler.

Increasing Curvature increases the maximum speed, while decreasing Curvature decreases the maximum speed.

Lead Line

Lead Line is the speed Butler will travel when it is not stitching. (For example, when traveling from the stop point of one pattern to the start point of another.)

Increment

Increment sets the distance a pattern will travel when moved with the directional buttons. The default is one-tenth of an inch.

Advanced

Machine Type

Machine Type should match the make of your quilting machine. Machine Type ensures that Butler can properly communicate with your specific quilting machine.

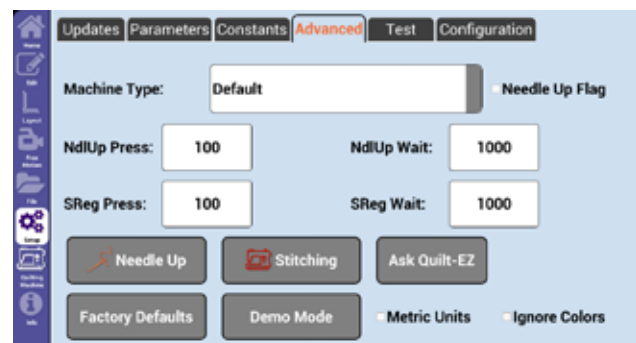
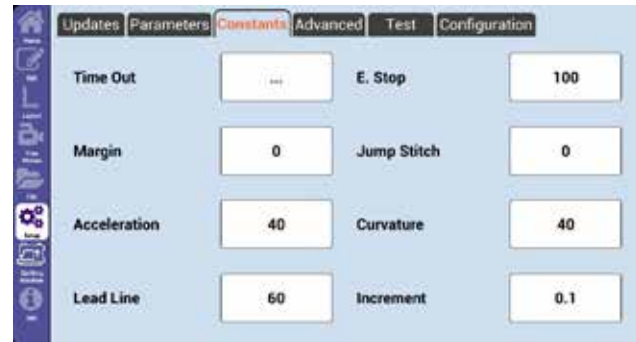

Machine Type must be changed from Default if Handle Bar connections are used. If not using handle bra connections, Default or a custom mode should be selected.

Needle Up Flag

Needle Up Flag value is set automatically, if required, when selecting Machine Type.

NdlUp Press

NdlUp Press sets the amount of time that Butler sends a signal that the needle up button has been pressed to your quilting machine to Needle Up, and should not need to be changed.

NdlUp Wait

NdlUp Wait sets the amount of time that Butler waits after sending the needle up signal to your quilting machine. This should not need to be changed.

SReg Press

SReg Press sets the amount of time that Butler sends the signal that the stitch regulator button has been pressed to your quilting machine. This should not need to be changed.

SReg Wait

SReg Wait sets the amount of time that Butler waits after sending the signal to your quilting machine to begin stitching. This should not need to be changed.

Needle Up

Needle Up tests your needle up by performing a full cycle of needle up and needle down.

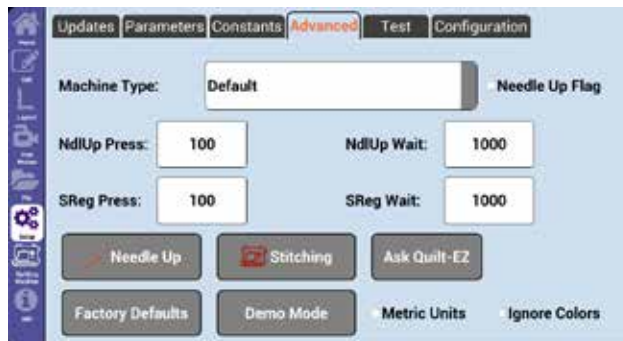

Stitching

Stitching tests the stitch regulator by activating it for a short period of time.

Ask Quilt-EZ

Ask Quilt-EZ sends an email to the product manufacturer. It can be used for troubleshooting and general questions about Butler.

Factory Defaults

Factory Defaults resets the values in the Constants and Advanced Tabs back to factory defaults. This includes setting the machine type in the Advanced tab to Default.

Factory Defaults does not affect Files or folders stored in the internal or external memory.

Demo Mode

Demo mode is used in commercial settings to set the machine in repetitive motion and is password protected.

Metric Units

When the Metric Units check box is checked, Butler uses centimeters instead of inches for all measurements.

Ignore Colors

Certain digitized pattern files, such as .4QB, specify where on the pattern different color threads should be used. When Butler detects a thread color change, it will stop quilting and prompt you to change the color of the thread. Ignore colors is a way to bypass the thread color stops in those patterns.

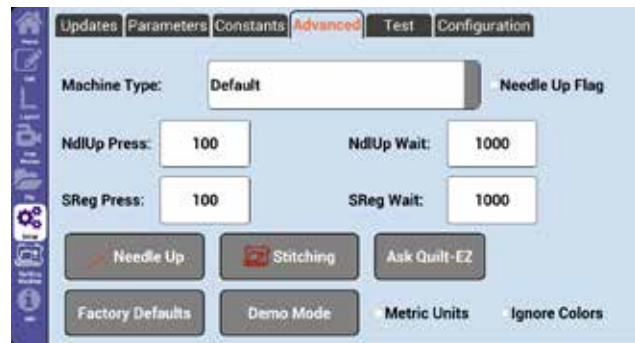

Test

Test is used to test if the Butler motor box is communicating properly with the quilting machine and if the motors are running to factory specifications.

These tests are mostly for use in factory.



TEST ALL

Test All will test the communication of Butler to your stitch regulator, as well as the encoder counts for both the X and Y motors. (If you are plugged into the handle bar port, this will return communication failed every time because the handle bars aren't providing feedback that the command was received.)

TEST X

Test X will test the encoder counts of the X motor only.

TEST Y

Test Y will test the encoder counts of the Y motor only.

PORT D

The handle bars on some machines will plug into the Butler motor box. Port D tests the communication between Butler and the handle bars for machines that do not plug into the Stitcher box port of the Butler motor box.

When pressed, Port D Sends the needle up and stitching commands to the handle bars to verify functionality.

Configuration

Configuration is password protected and contains settings that should only be changed by an authorized dealer.



Stitch Regulator



Access the stitch regulator user interface.

Stitcher User Interface

Pressing the sewing machine icon will show your Stitcher user interface on Butler's display.

If your stitcher user interface is not compatible with the Butler display or is not currently connected to Butler, this icon will not appear.

Information



Help with icons

Information



Information Mode is used to explain the interface of Butler on the spot.

Press the Information icon, then press any icon you would like to learn more about. (An example of pressing the Home icon is at right.)

A window will appear with a brief description of the feature and the option to view a video explanation of the icon.

Information

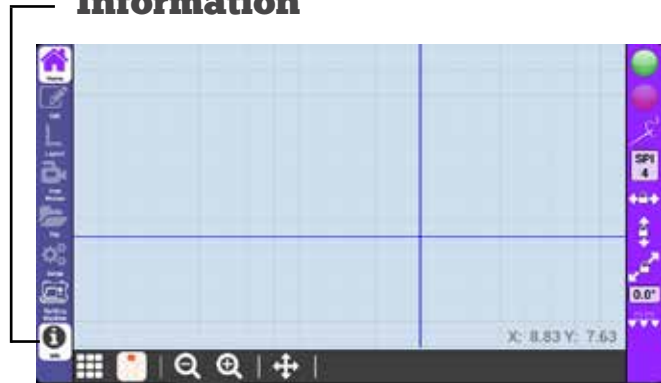

Definitions

- Home Location** The top left corner of the Quilt Area or Pattern Box. This is also known as zero/zero or point of origin.
- Layout** A Layout consists of the quilt area, Pattern Boxes, and all the patterns seen in the pattern view.
- Pattern Box** A Pattern Box is a portion of the quilt area used to contain patterns.
Though commonly used to represent different quilt blocks, Pattern Boxes can be any shape or dimension.
- Pattern View** The Pattern View is the screen used to view the patterns and pattern boxes of the layout.
If a Layout contains more than one Pattern Box, navigation arrows will appear on the pattern view screen to switch between pattern boxes.
- Quilt Area** The Quilt Area is the entire quitable area of your quilting machine, or the area inside the top left, top right, bottom left, and bottom right corners of your machine's reach.
By default, the quilt area is the same dimensions of the first pattern box in a layout.



Quilt
EZ

www.quilt-ez.com

© 2013 Quilt-EZ. All rights reserved.